

Applied Robotics with the SumoBot

Student Guide

VERSION 1.0

PARALLAX 

WARRANTY

Parallax Inc. warrants its products against defects in materials and workmanship for a period of 90 days from receipt of product. If you discover a defect, Parallax Inc. will, at its option, repair or replace the merchandise, or refund the purchase price. Before returning the product to Parallax, call for a Return Merchandise Authorization (RMA) number. Write the RMA number on the outside of the box used to return the merchandise to Parallax. Please enclose the following along with the returned merchandise: your name, telephone number, shipping address, and a description of the problem. Parallax will return your product or its replacement using the same shipping method used to ship the product to Parallax.

14-DAY MONEY BACK GUARANTEE

If, within 14 days of having received your product, you find that it does not suit your needs, you may return it for a full refund. Parallax Inc. will refund the purchase price of the product, excluding shipping/handling costs. This guarantee is void if the product has been altered or damaged. See the Warranty section above for instructions on returning a product to Parallax.

COPYRIGHTS AND TRADEMARKS

This documentation is Copyright 2005 by Parallax Inc. By downloading or obtaining a printed copy of this documentation or software you agree that it is to be used exclusively with Parallax products. Any other uses are not permitted and may represent a violation of Parallax copyrights, legally punishable according to Federal copyright or intellectual property laws. Any duplication of this documentation for commercial uses is expressly prohibited by Parallax Inc. Duplication for educational use is permitted, subject to the following Conditions of Duplication: Parallax Inc. grants the user a conditional right to download, duplicate, and distribute this text without Parallax's permission. This right is based on the following conditions: the text, or any portion thereof, may not be duplicated for commercial use; it may be duplicated only for educational purposes when used solely in conjunction with Parallax products, and the user may recover from the student only the cost of duplication.

This text is available in printed format from Parallax Inc. Because we print the text in volume, the consumer price is often less than typical retail duplication charges.

BASIC Stamp, Stamps in Class, Board of Education, Boe-Bot SumoBot, SX-Key and Toddler are registered trademarks of Parallax, Inc. If you decide to use registered trademarks of Parallax Inc. on your web page or in printed material, you must state that "(registered trademark) is a registered trademark of Parallax Inc." upon the first appearance of the trademark name in each printed document or web page. HomeWork Board, Parallax, and the Parallax logo are trademarks of Parallax Inc. If you decide to use trademarks of Parallax Inc. on your web page or in printed material, you must state that "(trademark) is a trademark of Parallax Inc.", "upon the first appearance of the trademark name in each printed document or web page. Other brand and product names are trademarks or registered trademarks of their respective holders.

ISBN 1-928982-34-4

DISCLAIMER OF LIABILITY

Parallax Inc. is not responsible for special, incidental, or consequential damages resulting from any breach of warranty, or under any legal theory, including lost profits, downtime, goodwill, damage to or replacement of equipment or property, or any costs of recovering, reprogramming, or reproducing any data stored in or used with Parallax products. Parallax Inc. is also not responsible for any personal damage, including that to life and health, resulting from use of any of our products. You take full responsibility for your BASIC Stamp application, no matter how life-threatening it may be.

INTERNET DISCUSSION LISTS

We maintain active web-based discussion forums for people interested in Parallax products. These lists are accessible from www.parallax.com via the Support → Discussion Forums menu. These are the forums that we operate from our web site:

- [BASIC Stamps](#) – This list is widely utilized by engineers, hobbyists and students who share their BASIC Stamp projects and ask questions.
- [Stamps in Class[®]](#) – Created for educators and students, subscribers discuss the use of the Stamps in Class curriculum in their courses. The list provides an opportunity for both students and educators to ask questions and get answers.
- [Parallax Educators](#) – Exclusively for educators and those who contribute to the development of Stamps in Class. Parallax created this group to obtain feedback on our curricula and to provide a forum for educators to develop and obtain Teacher's Guides.
- [Translators](#) – The purpose of this list is to provide a conduit between Parallax and those who translate our documentation to languages other than English. Parallax provides editable Word documents to our translating partners and attempts to time the translations to coordinate with our publications.
- [Robotics](#) – Designed exclusively for Parallax robots, this forum is intended to be an open dialogue for robotics enthusiasts. Topics include assembly, source code, expansion, and manual updates. The Boe-Bot[®], Toddler[®], SumoBot[®], HexCrawler and QuadCrawler robots are discussed here.
- [SX Microcontrollers and SX-Key](#) – Discussion of programming the SX microcontroller with Parallax assembly language SX – Key[®] tools and 3rd party BASIC and C compilers.
- [Javelin Stamp](#) – Discussion of application and design using the Javelin Stamp, a Parallax module that is programmed using a subset of Sun Microsystems' Java[®] programming language.

ERRATA

While great effort is made to assure the accuracy of our texts, errors may still exist. If you find an error, please let us know by sending an email to editor@parallax.com. We continually strive to improve all of our educational materials and documentation, and frequently revise our texts. Occasionally, an errata sheet with a list of known errors and corrections for a given text will be posted to our web site, www.parallax.com. Please check the individual product page's free downloads for an errata file.

Table of Contents

Preface	iii
Introduction.....	iii
Educator Resources.....	iv
The Stamps In Class Educational Series.....	iv
Foreign Translations.....	v
Special Contributors.....	vi
Chapter #1: Mechanical Adjustments	7
Before You Get Started.....	7
Small Adjustments can Make a Big Difference	7
ACTIVITY #1: Adjusting the Plow.....	8
ACTIVITY #2: Preventing Servo SlowDown.....	16
ACTIVITY #3: Friction Forces - Your SumoBot's Allies.....	22
Summary.....	38
Chapter #2: EEPROM Tricks and Program Tips	41
EEPROM and Program Management.....	41
ACTIVITY #1: A Closer Look at the EEPROM	42
ACTIVITY #2: Using and Reusing Variables.....	50
ACTIVITY #3: Program On/Off with Reset	55
ACTIVITY #4: Pushbutton, LED, and Speaker.....	58
ACTIVITY #5: Pushbutton Program Mode Selection	65
ACTIVITY #6: Integrating Programs.....	69
Summary.....	75
Chapter #3: Sensor Management	77
Sensors - Testing, Tuning, and Storing the Results.....	77
ACTIVITY #1: Testing and Tuning Infrared Object Detectors	78
ACTIVITY #2: A Closer Look at the QTI Line Sensors.....	95
ACTIVITY #3: Self Calibrating QTI Sensors.....	102
ACTIVITY #4: Reading the QTI Sensors More Quickly.....	107
ACTIVITY #5: Adding and Testing Sensors and Indicators	117
ACTIVITY #6: Testing All Sensors	122
ACTIVITY #7: Organizing Sensors with Flag Bits	129
ACTIVITY #8: Variable Management for Large Programs.....	132
Summary.....	140
Chapter #4: Navigation Tips	143
Sensor Flags and Navigation States.....	143
ACTIVITY #1: Servo Control with Lookup Commands.....	144
ACTIVITY #2: Setting Your Sights on the Opponent.....	155

ACTIVITY #3: Using Peripheral Vision.....	164
ACTIVITY #4: Introduction to State Machines and Diagrams.....	170
ACTIVITY #5: Search Pattern and Tawara Avoidance	176
ACTIVITY #6: Fully Functional Sumo Example Programs.....	186
Summary.....	203
Chapter #5: Debugging and Datalogging	207
Seeing what it Sees and Understanding what it Does	207
ACTIVITY #1: Using the LED to Signal an Event.....	208
ACTIVITY #2: Conditional Compiling.....	212
ACTIVITY #3: Debugging Problem Behaviors	216
ACTIVITY #4: Datalogging a Competition Round.....	233
Summary.....	253
Appendix A: System Requirements and Parts Listing.....	255
Index.....	259

Preface

INTRODUCTION

Robotics is currently enjoying ever increasing popularity with students. Especially when it involves a contest or competition, enthusiasm runs high as participants put everything they've got into their robots in hopes of winning top honors. With this in mind, Parallax developed the SumoBot[®] Robot Competition Kit and SumoBot Competition Ring as an inexpensive way for technology, programming, pre-engineering, and engineering classes to hold their own robotics competitions.

This textbook guides students through a variety of electronics, programming and physics activities as they prepare their SumoBot robots for SumoBot vs. SumoBot competition. Each of the principles presented are of general value to robotics students, applied in such a way as to add something to the SumoBot's competition performance.

Examples from electronics are mostly review from *What's a Microcontroller* and *Robotics with the Boe-Bot*, the entry-level texts to the Stamps in Class series, and include basics such as controlling LED indicators, speakers, and servos. Sensor basics include digital devices like pushbuttons and infrared receivers as well as analog devices like the QTI line sensors, which involve RC-decay measurements. More advanced electronic topics such as frequency response and thresholds for RC-decay measurements are also included.

Physics principles include introductions to time vs. distance at a constant velocity, force, mass, acceleration, coefficients of friction, and free body diagrams. While the physics experiments are optional, they can give students a new view to the direct benefit of experimentation to mechanical designs.

The programming topics in this book include many of the basics, such as looping, conditions, subroutines, saving variable space, using compiler directives, and adhering to coding conventions for the sake of debugging and reusable code. Some unique robotics and embedded systems topics are also included, such as sensor management, state machine design, and datalogging to capture real-time sensor events and navigation states for isolating robotic misbehaviors.

EDUCATOR RESOURCES

While the SumoBot Competition kit is designed for the classroom, it really provides an excellent starting point for the robotics enthusiast who wants to have a first taste of robot sumo wrestling. This book is written for ages 14 and up, and it contains lessons that can be useful additions to a variety of courses, including robotics, physics, technology, and pre-engineering.

Students as well as hobbyists working through this text are encouraged to use the public Stamps in Class forum to collaborate on the questions, exercises and projects at the end of each chapter. You can get there by going to forums.parallax.com, then click the Stamps in Class link.

As of this 1.0 revision, there are no answer keys or teachers guides available. Parallax does, however, have many resources and a support forum specially designed for instructors to use as a collaborative tool. Instructors should contact Parallax Inc. directly for more details.

THE STAMPS IN CLASS EDUCATIONAL SERIES

Applied Robotics with the SumoBot is considered an advanced text in the Stamps in Class educational series, and it is recommended that the student be familiar with the concepts introduced in *Robotics with the Boe-Bot*. All of the books listed are available for free download from www.parallax.com. The versions cited below were current at the time of this printing. Please check our web sites www.parallax.com or www.stampsinclass.com for the latest revisions; we continually strive to improve our educational program.

Stamps in Class Student Guides:

There are two entry-level text to choose from; either one is an appropriate gateway to the rest of the series.

“What’s a Microcontroller?”, Student Guide, Version 2.2, Parallax Inc., 2004
“Robotics with the Boe-Bot”, Student Guide, Version 2.2, Parallax Inc., 2004

For a well-rounded introduction to the design practices that go into modern devices and machinery, continue on with the following titles:

“Applied Sensors”, Student Guide, Version 1.3, Parallax Inc., 2003
“Basic Analog and Digital”, Student Guide, Version 1.3, Parallax Inc., 2004
“Industrial Control”, Student Guide, Version 1.1, Parallax Inc., 1999

Educational Project Kits:

Elements of Digital Logic, *Understanding Signals* and *Experiments with Renewable Energy* focus more closely on topics in electronics, while *StampWorks* provides a variety of projects that are useful to hobbyists, inventors and product designers interested in trying a variety of projects. *Advanced Robotics with the Toddler* further develops robotics skills with a bipedal walking robot.

“Elements of Digital Logic”, Student Guide, Version 1.0, Parallax Inc., 2003
“Experiments with Renewable Energy”, Student Guide, Version 1.0, Parallax Inc., 2004
“StampWorks”, Manual, Version 1.2, Parallax Inc., 2001
“Understanding Signals”, Student Guide, Version 1.0, Parallax Inc., 2003
“Advanced Robotics: with the Toddler”, Student Guide, Version 1.2, Parallax Inc., 2003

Reference

This book is an essential reference for all Stamps in Class Student Guides. It is packed with information on the BASIC Stamp series of microcontroller modules, our BASIC Stamp Editor, and our PBASIC programming languages.

“BASIC Stamp Manual”, Version 2.2, Parallax Inc., 2005

FOREIGN TRANSLATIONS

Parallax educational texts may be translated to other languages with our permission (e-mail stampsinclass@parallax.com). If you plan on doing any translations please contact us so we can provide the correctly-formatted MS Word documents, images, etc. We also maintain a discussion group for Parallax translators which you may join. Go to www.yahogroups.com and search for “Parallax Translators.” This will ensure that you are kept current on our frequent text revisions.

SPECIAL CONTRIBUTORS

Parallax Inc. would like to recognize the Education Team members who made this book possible: Education and Project Manager Aristides Alvarez, Author and Engineer Andy Lindsay, Technical Illustrator Rich Allred, Graphic Designer Jen Jacobs, and Technical Editor Stephanie Lindsay. Special thanks also go to Ryan Clarke in Tech Support and Kris Magri in Education for their insightful and speedy review, and, as always, to Ken Gracey, the founder of Parallax Inc.'s Stamps in Class educational program.

Chapter #1: Mechanical Adjustments

BEFORE YOU GET STARTED

To complete the activities in this book, you will need to build, program and test two complete SumoBot robots by following the activities in the *SumoBot Manual*. Also, since *Applied Robotics with the SumoBot* is an advanced robotics text that builds upon the concepts introduced in *Robotics with the Boe-Bot*, familiarity with that material is recommended. *Robotics with the Boe-Bot* is available for download from www.parallax.com.

You will also need additional electronic components and a SumoBot Robot Competition Ring poster. The complete robot kits and these other items are all included in the SumoBot Robot Competition Kit. If you already own two SumoBot robots, the components and poster can also be purchased separately from www.parallax.com. A few common household items are also needed for some activities. Please see Appendix A for the full parts listings.

As you go through the activities in this text, you can type all of the program code directly into the BASIC Stamp Editor from the listings in this book, or you can download the listed programs from the SumoBot Robot Competition Kit product page at www.parallax.com.

SMALL ADJUSTMENTS CAN MAKE A BIG DIFFERENCE

This chapter introduces some of the mechanical adjustments you can make to your SumoBot robot to improve its performance against other SumoBots. They include plow adjustments, making sure your servos are running at full speed, and modifications you can make to improve your SumoBot's grip on the ring.

When it's SumoBot vs. SumoBot, something as simple as a small adjustment to the plow can make a big difference, as you will see in Activity #1. While motor speed doesn't make as much of a difference, it is another factor that can impact a SumoBot's likelihood of winning each round. Activity #2 will demonstrate how taking too much time to read sensors between delivering control pulses to the servos can slow your SumoBot down.

Friction is that force which prevents your SumoBot from sliding. More friction between the SumoBot's tire tread and the sumo ring means the SumoBot can push harder against

its opponent. The less friction, the more easily the SumoBot slips, which means it can no longer push as hard.

There are two ways to increase the friction between the tire tread and sumo ring. First, increase the SumoBot's weight, and second, find the best possible tread material. The interesting thing about tire tread materials is that they have to be paired with the material the sumo ring is made out of. While one material might work best in the SumoBot Competition Ring poster, a different material might work better on a painted wood surface. Activity #3 introduces experiments you can perform to quantify the increases in friction from both increasing the SumoBot's weight and changing the tread materials.

ACTIVITY #1: ADJUSTING THE PLOW

One of the keys to increasing your SumoBot's chances of winning a match against another Parallax SumoBot is adjusting the plow so that it's more likely to pass under the opponent's plow. For example, the "winning" SumoBot in Figure 1-1 has the mechanical advantage, with its opponent off balance. In this activity, you will repeatedly test and adjust your SumoBots' plows while looking for the setting that will give one of your SumoBots the best chances in the sumo ring.

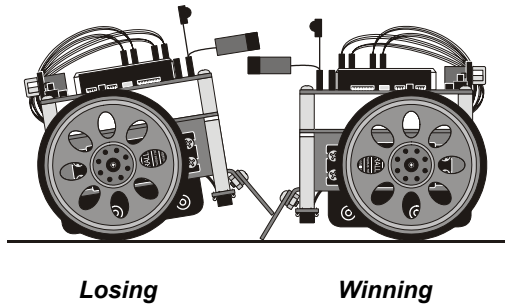

Figure 1-1
SumoBots Wrestling
*The one on the right
has the advantage*

Parts Required

- (2) Fully assembled and tested Parallax SumoBot robots
- (1) SumoBot Competition Ring poster, or other sumo ring
- Clear tape (not included)
- Black felt-tip marker (not included)

Setting up the SumoBot Competition Ring Poster

The SumoBot robot and SumoBot Robot Competition Ring poster are for indoor use only. For best results, follow these setup instructions:

- √ Unfold the SumoBot Competition Ring poster, and re-fold it the opposite way so the creases will lie flat, then unfold it again.
- √ Find a location with these characteristics:
 - Indoors, and well away from direct or indirect sunlight
 - Fluorescent or indirect incandescent lighting
 - Hard, flat, smooth surface such as a large table or floor; not on carpet
 - Surface any color other than white, and preferably not super-shiny, or the infrared detectors may see it
 - No walls or other objects within 1 meter of the outside of the ring
- √ Place the ring on this surface, and secure the corners and edges with clear tape to make it lie flat.
- √ If, from frequent folding and unfolding, the creases start to appear white, touch them up with a black felt-tip marker.
- √ If possible, place some heavy books on top of the creases for a couple of days to flatten them out.

Initial Adjustments

The plow is held to the chassis by two screws shown in Figure 1-2. Each screw passes through a slot in the plow. Adjusting the plow is a simple matter of loosening the two screws, changing the plow's position, then retightening the screws. Each slot only has a few millimeters of wiggle room. Even so, the slight adjustments you can make to the plow's height and tilt can make a big difference in performance.

- √ Start by adjusting each plow so that it is flush to the sumo ring's surface along its whole length, as shown in Figure 1-2.

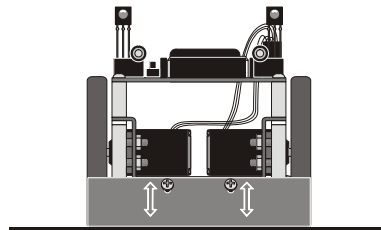

Figure 1-2
Adjusting the Plow

Testing Plow Adjustments

A simple program to make each SumoBot go forward should be used to test the plows. This eliminates the possibility of IR object detectors interfering with the SumoBot's forward motion. For example, if one of the SumoBot's IR detectors briefly misses its opponent, the SumoBot will hesitate and might not be going full speed when the two SumoBots collide. It's true that this will also happen during a match, but during practice it's best to test only one variable at a time, in this case, the plow adjustment.



Example Source Code Available

Remember, you can save yourself some typing and debugging! The example BASIC Stamp programs printed in this text are available for free download as .bs2 source code from the *Applied Robotics with the SumoBot* product page at www.parallax.com. The various modifications and "Your Turn" programs are not provided.

- √ Label both your SumoBots so that you can distinguish them. If A and B aren't interesting enough labels, some searching on the Internet will yield names of sumo legends as well as present stars.
- √ Enter Forward100Pulses.bs2 into the BASIC Stamp Editor (listed on the next page).
- √ Load the program into both SumoBots.
- √ Place both SumoBots facing each other as shown in Figure 1-3.

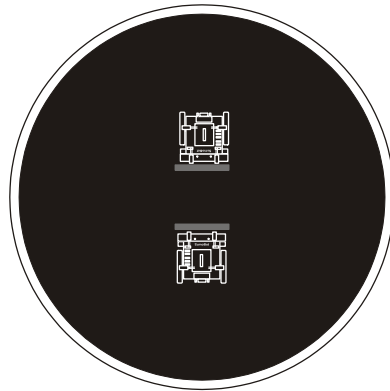

Figure 1-3
Facing Off on the
Shikiri Lines

*Place the SumoBots
so that they are
directly facing each
other before pressing
and releasing Reset.*

- √ Press and release both SumoBot Reset buttons at the same time.
- √ Make notes on which SumoBot appeared to be winning the match and why.

- √ Repeat five to ten times to be sure which SumoBot's plow adjustment has the advantage.
- √ Adjust the plow of the SumoBot that appeared to lose more often, and repeat the test.
- √ When you are confident that one of your SumoBots has a winning plow adjustment, try lots of different adjustments on the other SumoBot to find out if there is any better adjustment that can make it the winner.
- √ When you are satisfied with your winning SumoBot's plow, leave its adjustment as-is, and tune the other SumoBot's plow until its chances of winning/losing are close to even.

Example Program: Forward100Pulses.bs2

```
' -----[ Program Description ]-----
' Applied Robotics with the SumoBot - Forward100Pulses.bs2
' SumoBot goes forward 100 pulses after Reset button is pressed and released.
' To repeat the forward motion, press/release the Reset button twice.
'
' {$STAMP BS2}
' {$PBASIC 2.5}

' -----[ I/O Definitions ]-----
ServoLeft      PIN    13                ' Left servo connected to P13
ServoRight     PIN    12                ' Right servo connected to P12

' -----[ EEPROM Data ]-----
RunStatus      DATA  0                ' Start with program not running

' -----[ Variables ]-----
temp           VAR    Byte             ' Temporary variable
counter        VAR    Byte             ' FOR...NEXT loop counter

' -----[ Initialization ]-----
DEBUG CLS                                ' Clear the Debug Terminal
Reset_Button:

  READ RunStatus, temp                    ' read current status
  temp = ~temp                            ' invert status
  WRITE RunStatus, temp                   ' save for next reset
  IF (temp > 0) THEN                      ' 0 -> End, 1 -> Main routine
    DEBUG "Press/release Reset..."
  END
ENDIF
```

```

DEBUG "Main program running...", CR           ' Display program status
' -----[ Main Routine ]-----
FOR counter = 1 TO 100                         ' Deliver 100 forward pulses
  PULSOUT ServoLeft, 850
  PULSOUT ServoRight, 650
  PAUSE 20
NEXT
DEBUG "Done!", CR,                             ' User instructions
  "Press/release reset", CR,
  "twice to restart...", CR
END

```

Understanding Forward100Pulses.bs2

When you click the BASIC Stamp Editor's Run button, the program downloads to the SumoBot's BASIC Stamp. The `Reset_Button` routine in the Initialization displays the message "Press/release Reset...", then it ends the program. When you press and release the Reset button on the SumoBot board, the same `Reset_Button` routine displays the message "Main program running..." and moves on to the Main Routine and the servos start turning. If you leave the SumoBot connected to its serial cable and press/release the Reset button a third time, you will again see the "Press/release Reset button" prompt. Repeat a fourth time, and the servos will run for a couple seconds.

The reason the `Reset_Button` routine is able to perform this function is because it manipulates values stored in the SumoBot's EEPROM program memory. The portion of this memory that is not used to store the program can be used to store values. While the BASIC Stamp's RAM memory is erased whenever the power is turned off or the Reset button is pressed and released, the EEPROM memory retains the values stored in it. That's why the same program runs after your turn the SumoBot's power off, then back on.

The ability to retrieve values stored in EEPROM, change them, and store them back into EEPROM is what allows the `Reset_Button` routine to track whether you've pressed and released the Reset button an odd or even number of times. The mechanics of exactly how the `Reset_Button` routine does this is covered in more detail in Chapter 2, Activity #2. For now, just keep in mind that the `Reset_Button` routine allows the program to continue to the Main Routine when you have pressed and released the SumoBot's Reset button an odd number of times. That means, the first, third, fifth,... time you press and release the Reset button, the program will continue to the Main Routine, and the servos will turn for about 2 1/2 seconds. Whenever you have pressed/released the Reset button

an even number of times, including zero, the `Reset_Button` routine just displays the message prompting you to press the Reset button, then it ends the program ends.

If you have already completed *Robotics with the Boe-Bot*, the forward motion code in `Forward100Pulses.bs2`'s Main Routine should be very familiar. Although Chapter 4, Activity #1 features a quick review of the servo control principles that were introduced in *Robotics with the Boe-Bot*, the information box below lists a few activities you can try to get up to speed.

Understanding How Pulses Control Servos

If you have not already worked through *Robotics with the Boe-Bot v2.2*, download it from www.parallax.com, and try the following chapters and activities:

Chapter 2, Activity #6

Chapter 3, Activity #4

Chapter 4, Activity #1 to Activity #6

The servos are connected to the same I/O pins, so the example programs will run correctly in your SumoBot. The only part that will not work is the piezospeaker, which is connected to P4 in *Robotics with the Boe-Bot*. If your piezospeaker circuit is connected to P1, simply update every instance of `FREQOUT 4, 2000, 3000` to `FREQOUT 1, 2000, 3000`.



Figure 1-4 shows the servo connections you made in the *SumoBot* text. The left servo connects to header X7 on the SumoBot board. The plug at the end of the servo's cable plugs into X7 so that the black wire connects to the B pin, the red wire connects to the R pin, and the white signal line connects to the pin labeled 13. Traces on the SumoBot printed circuit board in turn connect the header pin labeled 13 to BASIC Stamp I/O pin P13. The also connect the pin labeled R to Vdd, which is the board's regulated 5 V power supply, and the pin labeled B to Vss, which is the board's ground or 0 V connection. The right servo connects to header X6. The difference with X6 is that it connects that servo's white signal line to BASIC Stamp I/O pin P12 instead of P13.

Figure 1-4 SumoBot Servo Connections

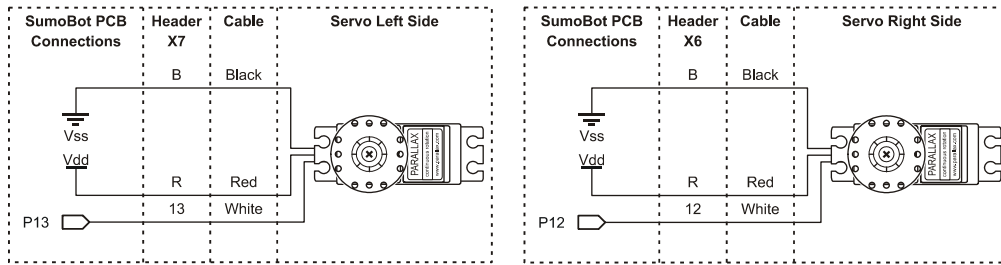

The instructions that make the SumoBot move forward starts with these `PIN` declarations:

```
ServoLeft    PIN    13
ServoRight   PIN    12
```

The SumoBot's left servo is connected to P13, so I/O pin P13 is given the name `ServoLeft`. Likewise, P12 is connected to the right servo, so it's named `ServoRight`.

In order for the program to apply 100 pulses, a `counter` variable is declared:

```
counter      VAR    Byte
```

This `FOR...NEXT` loop delivers 100 forward pulses to the SumoBot's servos. According to *Robotics with the Boe-Bot*, this loop delivers 40.65 pulses per second, so the SumoBot will roll forward for $100 \div 40.65 = 2.46$ seconds.

```
FOR counter = 1 TO 100
  PULSOUT ServoLeft, 850
  PULSOUT ServoRight, 650
  PAUSE 20
NEXT
```

Your Turn - Does Angle of Approach Matter?

By experimenting with different angles of approach, you might (or might not) find an even more "winning combination". Figure 1-5 shows examples of two different approaches. The edge of a SumoBot's plow collides with the flat of the other's (left). The SumoBot is using a curved approach (right). They aren't necessarily better approaches, but they are worth investigating for the sake of better understanding the relative merits and drawbacks of each.

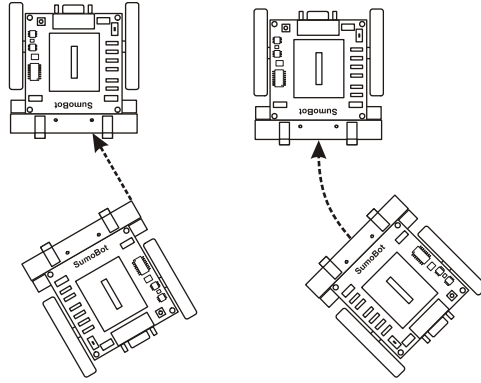

Figure 1-5
Other Collision Paths

One SumoBot can approach at an angle, or even with a curved path.



Do not adjust your plows.

The strategies presented in this book will use the head-on approach. You can modify your programs (and the plows) to optimize for different approach angles, but wait until after Chapter 5.

- √ Test a variety of approach angles and plow intersection points with the same full-speed-forward settings.

To test curved approaches, you will need make one of the servos turn slower than the other. You can do this by modifying the code in the Main Routine. Simply reduce one of the `PULSOUT` command's *Duration* arguments closer to 750. If you want it to curve right, change `PULSOUT ServoRight, 650` to `PULSOUT ServoRight, 720`. For a tighter turn, try `PULSOUT ServoRight, 730`. `PULSOUT ServoRight, 735` will make the turn tighter still. For a wider turn, try `PULSOUT ServoRight, 715`, or even `PULSOUT ServoRight, 710`.

You can repeat this for left turns. First, restore the right servo to `PULSOUT ServoRight, 650`. Then, change the left servo's control signal to `PULSOUT ServoLeft, 780`. The same adjustment pattern applies for the left servo. For tighter turns, adjust the `PULSOUT` commands *Duration* argument closer to 750, and for wider turns adjust it closer to 850.

- √ Experiment with a curved approach with one SumoBot and a straight approach with the other.
- √ Also experiment with curved vs. curved.



A notebook for your observations - keep notes on the various results you observe for developing wrestling strategies.

ACTIVITY #2: PREVENTING SERVO SLOWDOWN

A SumoBot that executes certain maneuvers more quickly will have an edge over a slower opponent. One of the things that can slow your SumoBot down is trying to read too many sensors between servo pulses. This activity examines how much time your SumoBot can actually take between servo pulses before it starts to slow down. Later activities will introduce ways to reduce the time it takes to read certain sensors.



Maximizing speed and strength

In robotics clubs, competitors often rely on new servo gear sets or DC motors along with hobby RC batteries to optimize their competition robot for speed and brute force.

Parts Required

- (2) Parallax SumoBot robots
- (8) New 1.5 volt AA batteries - same brand and type

Top Speed vs. Low Time

The high time of both pulse trains in Figure 1-6 control servo speed and direction. Because both pulse trains have high times of 1.7 ms, either pulse train will make a servo turn full speed counterclockwise. The problem is that full speed for a servo with 40 ms between pulses isn't quite as fast as the full speed for a servo with 20 ms between pulses. For example, the servo might turn 53 RPM with 20 ms pauses between pulses, but only 47 RPM with 40 ms.

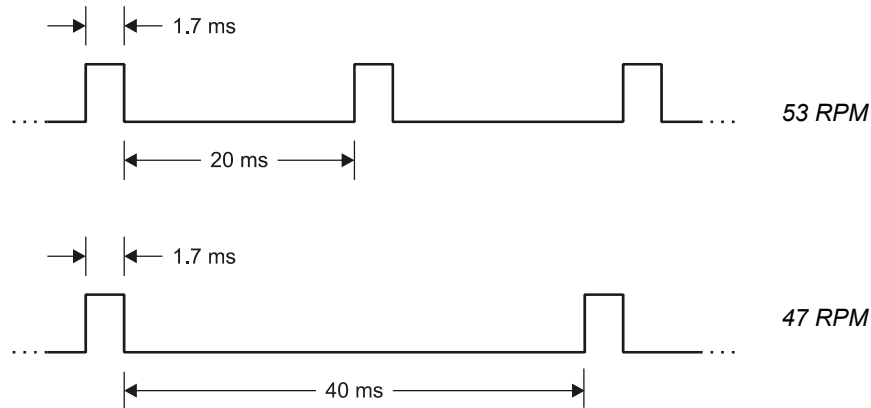
Figure 1-6 Top Speed vs. Low Time

As mentioned earlier, taking too much time between pulses to check sensors can cause the servos to slow down. IR object detectors don't take a very big bite out of the low time between servo pulses. Each one only takes a couple milliseconds to read. QTI line detectors, on the other hand, can take up to 20 milliseconds each. The time it takes a QTI to complete its measurement depends on ambient light and how reflective the surface is. The problem is, if both QTIs take 20 ms to read, that pushes the low time into the 40 ms range, which means the servos will slow down, which may put your SumoBot at a disadvantage.

In this activity, you will determine just how much time you can take between servo pulses before the servos start to slow down. This will be an important consideration in the sensor management chapter. One of the goals of sensor management will be to figure out how to read as many sensors as possible between each servo pulse without exceeding the time limit. By making a note of the maximum low time before servo slowdown in this activity, you will have a key piece of information for the sensor management chapter.

Testing Speed vs. Low Time - How Much Does it Matter?

A SumoBot race is a good way to examine the speed difference a longer low time can make. Simply program both SumoBots to travel forward at full speed, with different low times. Both programs should deliver pulses in an infinite loop. Each program should also make use of the same initialization routine from Activity #1 so that you can use the Reset button to start and stop the race.

With a couple modifications to Forward100Pulses.bs2 from Activity #1, you'll be ready to go.

- √ Save Forward100Pulses.bs2 as ForwardLowTimeTest.bs2.
- √ Add a **LowTime** constant declaration:

```
LowTime      CON      20
```

- √ Change the **FOR...NEXT** loop in the Main Routine to a **DO...LOOP**, and substitute the **LowTime** constant for the 20 in the **PAUSE** command's *Duration* argument:

```
DO
  PULSOUT ServoLeft, 850
  PULSOUT ServoRight, 650
  PAUSE LowTime
LOOP
```

It's important to use new batteries in both SumoBots. It's also best to swap programs and re-test to make sure that one SumoBot doesn't happen to be slower than the other. This can be especially common in the classroom, where servos may have been subject to differing levels of wear and tear over time.

Example Program: ForwardLowTimeTest.bs2

- √ Load fresh alkaline batteries into both SumoBots.
- √ Enter and download ForwardLowTimeTest.bs2 to SumoBot A.
- √ Change the **LowTime CON** directive from 20 to 40.
- √ Download the modified program into SumoBot B.
- √ Set them on a flat surface for the race.
- √ Press/release both Reset buttons at the same time to start the race.
- √ Follow the SumoBots for 3 seconds, then press/release the Reset buttons again to end the race.
- √ Measure the distance each SumoBot traveled, and make a note of it.
- √ Divide the distance by 3 to calculate each SumoBot's speed in distance per second.
- √ Swap the programs so that SumoBot B now has the program with 20 ms pauses and SumoBot A has the program with 40 ms pauses.
- √ Repeat the race and measurement.

- √ Compare the results of the two trials and determine which program gives the SumoBot better performance.

```
' -----[ Program Description ]-----
' Applied Robotics with the SumoBot - ForwardLowTimeTest.bs2
' SumoBot goes forward indefinitely. Use the Reset button to start and stop
' the forward motion.
'
' {$STAMP BS2}
' {$PBASIC 2.5}

' -----[ I/O Definitions ]-----
ServoLeft      PIN    13          ' Left servo connected to P13
ServoRight     PIN    12          ' Right servo connected to P12

' -----[ EEPROM Data ]-----
RunStatus      DATA    0          ' Start with program not running

' -----[ Constants ]-----
LowTime        CON     20          ' Try 1 SumoBot with 20 ms pulses
' Try the other with 40 ms pulses

' -----[ Variables ]-----
temp           VAR     Byte        ' Temporary variable
counter        VAR     Byte        ' FOR...NEXT loop counter

' -----[ Initialization ]-----
DEBUG CLS          ' Clear the Debug Terminal

READ RunStatus, temp ' read current status
temp = ~temp       ' invert status
WRITE RunStatus, temp ' save for next reset
IF (temp > 0) THEN ' 0 -> End, 1 -> Main routine
  DEBUG "Press/release Reset..."
  END
ENDIF

DEBUG "Main program running...", CR ' Display program status

' -----[ Main Routine ]-----
DO ' Forward pulses indefinitely
  PULSOUT ServoLeft, 850
  PULSOUT ServoRight, 650
  PAUSE LowTime
```

```

LOOP
DEBUG "Press/release reset", CR,           ' User instructions
      "twice to restart...", CR
END
    
```

Your Turn - More Pulses, Less Distance

Chapter 4, Activity #3 in *Robotics with the Boe-Bot* demonstrates how the amount of time a servo turns translates to distance traveled. When there's less time between each pulse, the program will have to send the servos more pulses to make them turn for the same amount of time. This can make a huge difference in certain maneuvers, especially distance and turns. Let's take a closer look at turns. If the low time between pulses is cut in half, it means you have to deliver around twice as many pulses to execute the same maneuver.

- ✓ Save ForwardLowTimeTest.bs2 as ForwardLowTimeTestYourTurn.bs2
- ✓ Set the **LowTime CON** directive to 40.
- ✓ Replace the **DO...LOOP** in the Main Routine with this:

```

FOR counter = 1 to 15           ' Deliver 15 left turn pulses
  PULSOUT ServoLeft, 850
  PULSOUT ServoRight, 850
  PAUSE LowTime
NEXT
    
```

- ✓ Download the modified program to SumoBot A.
- ✓ Set the **LowTime CON** directive to 20.
- ✓ Modify the Main Routine again, this time doubling the number in the **FOR...NEXT** loop's **EndValue**:

```

FOR counter = 1 to 30           ' Deliver 30 left turn pulses
  PULSOUT ServoLeft, 850
  PULSOUT ServoRight, 850
  PAUSE LowTime
NEXT
    
```

- ✓ Download the modified program to SumoBot B.

The distance traveled will not be exactly the same because the servos don't turn as fast with 40 ms pauses. This means that you'll probably have to use a little less than twice as many pulses with 20 ms pauses to match the distance of the program with 40 ms pulses.

- √ Tune the `EndValue` in the `FOR...NEXT` loop with the 20 ms pauses to get as close as possible to the distance traveled with 40 ms pauses.

How Much Time Can the SumoBot Take between Pulses?

`ForwardLowTimeTest.bs2` can also be used to determine the maximum **PAUSE Duration** between pulses before servo slowdown sets in. You can do this by measuring a servo's speed with a 20 ms low time, then again with a 21 ms low time, then 22 ms, and so on.

- √ Slip a jumper wire under one of the rubber band tires as shown in Figure 1-7. This will serve as a marker for counting wheel revolutions.

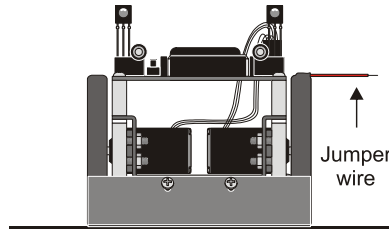

Figure 1-7
Jumper Wire Marker
under Tire Tread

- √ Start over with an unmodified version of `ForwardLowTimeTest.bs2`.
- √ Begin with the `LowTime` constant set to 20, and run the program.
- √ Press/release the Reset button to start the servos, and start counting revolutions.
- √ Press/release the Reset button 10 seconds later, and make a note of how many revolutions the wheel turned.
- √ Multiply this value by 6 to calculate the servo's rotational speed in RPM. For example, if the servo turned 8.75 revolutions in 10 seconds, the servo is turning at 52.5 RPM:

$$\frac{8.75 \text{ revolutions}}{10 \text{ seconds}} \times \frac{60 \text{ seconds}}{\text{minute}} = 52.5 \frac{\text{revolutions}}{\text{minute}} = 52.5 \text{ RPM}$$

- √ Change the `LowTime` constant to 21.

- √ Run the modified program.
- √ Repeat the 10 second measurement and record the servo speed.
- √ Keep increasing the **LowTime** constant and measuring servo speed until you note obvious speed decay.
- √ Record the maximum **LowTime** value you can use without slowing down your SumoBot in your notes for future reference.

Your Turn - Wheel Rotation Speed Measurements

You can also calculate the percent speed reduction for a given pause time. Here's an example of how to compare the percent speed reduction between programs with 20 and 40 ms pause times. Start by dividing the wheel's rotational speed (RPM) with 40 ms pause times by its rotational speed (RPM) with 20 ms pause times. Subtract the fractional value from 1, then multiply by 100%. If your result turns out to be a value like 12%, that means the SumoBot goes 12% slower with 40 ms low times.

$$\text{Percent speed reduction} = 100\% \times \left(1 - \frac{\text{RPM}(40\text{ms})}{\text{RPM}(20\text{ms})} \right)$$

- √ Calculate the percent impact of 40 ms vs. 20 ms pause times on your servo's speed.

ACTIVITY #3: FRICTION FORCES - YOUR SUMOBOT'S ALLIES

Friction between tire treads and the sumo ring surface is another performance issue that you will likely examine and reexamine as you customize your SumoBot. There are two areas that you can change to improve your SumoBot's traction on the sumo ring. The first is to increase the SumoBot's mass from 354 grams up to the maximum allowed 500 grams. The second is to experiment with tire tread materials that will grip the ring better. This activity explains some of the physics principles behind each of these strategies and introduces tests you can perform to measure the resulting changes in your SumoBot's ability to push harder against its opponent.

Measurements - Force Vs. Mass

Pounds and ounces are measurements of weight. Weight is the force a planet's gravity exerts on an object. Mass, on the other hand, is a measure of how much stuff an object is made of - a grand total of protons, neutrons, and electrons.

Scales that show both ounces and grams are not uncommon, likewise with scales that show both kilograms and pounds. They all appear to work because they are being used on the Earth's surface. When astronauts took equipment from the earth to the moon, the equipment weighed less because gravity on the moon isn't as strong. However, each piece of equipment still had the same mass (total protons neutrons and electrons). Since scales that measure mass are actually measuring mass based on earth-weight and calling it mass, those scales would incorrectly tell you the object had less mass on the moon.

Understanding the difference between weight (force) and mass isn't just required for space travel. There are lots of equations that involve force, mass, and acceleration that go into the design of all things mechanical. The designs of bridges, generators, airplanes, cars, and missiles all depend on the correct use of force and mass in a variety of equations. If an engineer tries to use a force value where a mass value was actually required, his/her design won't work right. Table 1-1 shows a list of forces, masses, and accelerations in three different systems - SI, cgs, and British Engineering.

Table 1-1: Units of Force, Mass, and Acceleration			
System of Units	Force	Mass	Acceleration
System International (SI)	Newton (N)	kilogram (kg)	meter per second squared (m/s ²)
cgs	dyne	gram (g)	centimeter per second squared (cm/s ²)
British Engineering	pound (lb)	slug	foot per second squared (ft/s ²)

The force exerted on an object is equal to its mass multiplied by the rate at which it accelerates. That's (F)orce = (m)ass × (a)cceleration:

$$F = m \times a$$



Newton's second law of motion states that the acceleration of an object is directly proportional the applied force and inversely proportional to its mass.

$$a = \frac{F}{m}$$

To get from this to $F = m \times a$, put the terms on opposite sides of the = sign, then multiply both sides by m.

Since weight is a force, and gravity is a form of acceleration, an equation you will find useful in your calculations is:

$$W = m \times g$$



The acceleration due to gravity is 9.8 m/s² in the SI system and 32 ft/s² in the British Engineering system.

Problem: An object has a mass of 0.75 kg, what's its weight in newtons?

Solution: Start with the equation $w = mg$, and figure out which system to use and which pieces of information you already know. Also, look at Table 1-1 again. The units of your result should be in kg×m/s². Since the mass is in kg units, we can start with the SI system. The acceleration due to gravity in the SI system is 9.8 m/s². Now that we know two pieces of the puzzle, we can calculate the third.

$$\begin{aligned} w &= mg \\ &= 0.75 \text{ kg} \times 9.8 \text{ m/s}^2 \\ &= 7.35 \text{ kg m/s}^2 \\ &= 7.35 \text{ N} \end{aligned}$$



A newton is in fact a kg m/s². Likewise, a pound is a slug ft/s².

Unit Conversions

There are 1000 grams in 1 kilogram. That's:

$$1000 \text{ g} = 1 \text{ kg}$$

If you divide both sides of the equal sign by one of these values, you will have 1 = conversion factor. For example:

$$1 = \frac{1 \text{ kg}}{1000 \text{ g}} \quad \text{and} \quad \frac{1000 \text{ g}}{1 \text{ kg}} = 1$$

If you measure an object's mass to be a certain number of grams, converting to kilograms is a matter of using the conversion factor that will make the units you don't want cancel out.

Problem: You measured your mass to be 280 g, and you want kg.

Solution: Multiply by the conversion factor with the g in the denominator.

$$1 = \frac{1 \text{ kg}}{1000 \text{ g}}$$

It will cancel out the g in the numerator of the term you are starting with (280 g), and the result will have units of kg.

	1 ft = 0.3048 m	1 lb = 16 oz	1 lb = 453.592 g
---	-----------------	--------------	------------------

Problem: Your scale gives you a measurement of 8 oz, but you need kilograms for your SI force calculations.

Solution: There isn't a single term in information box to get you from ounces to kilograms, but we do know how many ounces are in a pound, how many grams are in a pound, and how many grams are in a kilogram. Knowing this, you can make three fractions, all equal to 1, for conversion.

$$1 \text{ lb} = 16 \text{ oz} \rightarrow 1 = \frac{1 \text{ lb}}{16 \text{ oz}}$$

$$1 \text{ lb} = 453.6 \text{ g} \rightarrow 1 = \frac{453.6 \text{ g}}{1 \text{ lb}}$$

$$1000 \text{ g} = 1 \text{ kg} \rightarrow 1 = \frac{1 \text{ kg}}{1000 \text{ g}}$$

Next, all you have to do is multiply 8 oz by 1 three times. Look closely at the second line of the calculation below. In this cascade of conversion factors, the oz measurements cancel, then the lb measurements cancel, then the g measurements cancel, and you are left with just kg units.

$$\begin{aligned}
 8\text{ oz} &= 8\text{ oz} \times 1 \times 1 \times 1 \\
 &= 8\text{ oz} \times \frac{1\text{ lb}}{16\text{ oz}} \times \frac{453.6\text{ g}}{1\text{ lb}} \times \frac{1\text{ kg}}{1000\text{ g}} \\
 &= 0.2268\text{ kg}
 \end{aligned}$$

These unit conversions take some practice; here are some tips:

- √ Find the equality with your desired result units first.
- √ Make it a conversion factor with the desired units in the numerator.
- √ Find equalities with units that link your starting units to your result units.
- √ To make them fractions equal to 1, start by making sure that the denominator of your first fraction cancels the units of the value you are starting with.
- √ Repeat that until you get to the desired result.

Friction Forces

Figure 1-8 shows the forces at work if you try to slide an object like a block along a flat surface like a table. The arrows are called vectors, and they indicate the magnitude and direction of the forces applied. The (W) vector in Figure 1-8 indicates gravity's action on the book's mass, a downward force on the table. The table responds with an equal and opposite force, which is typically labeled (N) for normal force. In this case, the term normal has a special meaning - it's the force that's perpendicular to the contact surface, and it prevents the block from falling through the table. (F) is the force applied that tries to slide the block along the table. The forces of friction between the block and the table (f_s or f_k) cause the table to oppose the applied force that's trying to make the block slide. If you're not pushing hard enough to make it slide, the force comes from static friction (f_s). If you have pushed hard enough to overcome the force of static friction and the block starts moving, the slightly weaker force of kinetic friction (f_k) takes over.

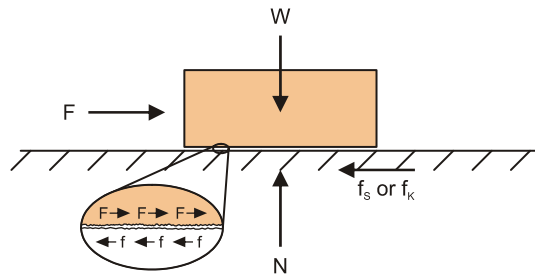

Figure 1-8
Forces Acting on an Object

Forces of friction that result from pushing an object along a level surface

Figure 1-8 also shows a close-up of the contact surfaces, where little components of the force you apply to the block and the frictional forces are opposing each other. While some of the frictional forces actually do come from the surface's roughness, there is also interaction between the molecules in the two surfaces that govern frictional forces.

Free body diagrams like the one in Figure 1-9 are used to analyze the forces at work for both static (non moving) and kinetic (moving) objects. There are two tricks to analyzing a free body diagram. The first is to set a convention for positive directions. For example, in Figure 1-9 the x axis is positive to the right, and the y axis is positive pointing up. The second trick is to add the forces up in each axis direction, and set the sum equal to zero. If a force vector is pointing in the negative direction, you are adding a negative value, in effect subtracting.

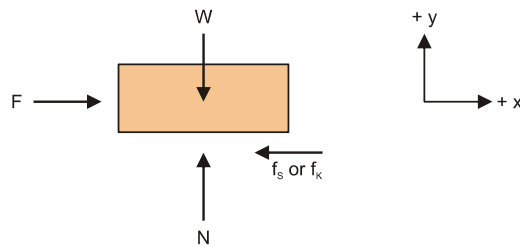

Figure 1-9
Free Body Diagram
with Positive x and y
Axes Shown

Here is how that analysis would work for Figure 1-9. Start by setting the sum of the forces in the x direction equal to zero:

$$\begin{aligned}\sum F_x &= 0 \\ F - f_s &= 0 \\ F &= f_s \\ f_s &= F\end{aligned}$$



The Greek letter sigma Σ denotes the sum of a list of values. So, $\Sigma F_x = 0$ can be read, "the sum of the forces in the x axis direction equals zero."

$f_s = F$ essentially states that the force of static friction is equal and opposite to the force applied on the object. The same rule can then be applied to the force in the y axis direction:

$$\sum F_y = 0$$

$$N - W = 0$$

$$N = W$$

$N = W$ indicates that the normal force, N , is pushing back just as hard as the object's weight is pushing down on the surface. This has to be true. If it wasn't, the block would sink through the table, or maybe the table would start sinking into the earth.



Newton's Third Law can be summarized like this: if two bodies (such as the block and the surface it's on) interact, each body exerts an equal and opposite force on the other.

The drawings of the forces acting on the block and setting the sum of all the forces equal to zero is dictated by this law.

Coefficients of Friction

Different pairs of surfaces tend to exert different kinetic and maximum static frictional forces. For example, if you try to slip your shoe along concrete on a sidewalk, it'll probably resist pretty strongly. However, if there's ice on the sidewalk, your shoe will slip right along it with barely any frictional force.

Since each pair of materials resists the applied force with different levels of f_s and f_k , a term called the coefficient of friction is used to predict how much force it will take to make one material slide along another. In the case of static friction, this coefficient, μ_s is the maximum force you can apply before the object starts sliding divided by the normal force. In the case of kinetic friction, μ_k is the force required to keep the object sliding, divided by the normal force.

$$\mu_s = \frac{f_{s,Max}}{N} \quad \text{and} \quad \mu_k = \frac{f_k}{N}$$



The Greek letter mu - μ - is commonly used for to denote coefficients of friction. μ is also a coefficient for units such as seconds, amps, and meters (μs , μA , μm). In those cases, μ is a different coefficient, with a value of one-one-millionth ($1/1,000,000$). If you are referring to the coefficient of static friction, μ_s , always remember to subscript the capital S. When referring to microseconds, it's just μs , with a lower-case 's'.

To appreciate how different the coefficients of friction can be for different pairs of materials, take a look at Table 1-2.

Materials	μ_s	μ_k
Rubber on Concrete	1.0	0.8
Copper on steel	0.53	0.36
Ice on ice	0.1	0.003



Strategy Consideration: The coefficient for each pair of materials is different. Let's say your class will have a contest on a painted wood ring, but you are using the SumoBot Competition Ring poster for practice. The tread material with the highest friction on the poster isn't necessarily the material with the highest friction on the painted surface. If you get the chance, test your collection of tread materials on the contest ring in advance.

Figure 1-10 shows a graph you may have seen or will likely see in a physics book at some point. The left side of the graph shows how the frictional force responds to the applied force while the object is at rest. As more force (F) is applied, the frictional opposing force increases by the same amount. When the applied force is more than the product of the coefficient of friction and the normal force, the object will start to slide. Once the object is sliding, the left side of the graph no longer applies. Since kinetic forces are now at work, the right side of the graph explains what happens next. The applied force can continue to increase, but all it does is increase the object's acceleration. Reason being, force of kinetic friction resisting the applied force just doesn't get larger than $\mu_k \times N$. Any force that exceeds this value contributes to acceleration, which can be calculated using $F = m \times a$.

Figure 1-10 Friction vs. Applied Forces

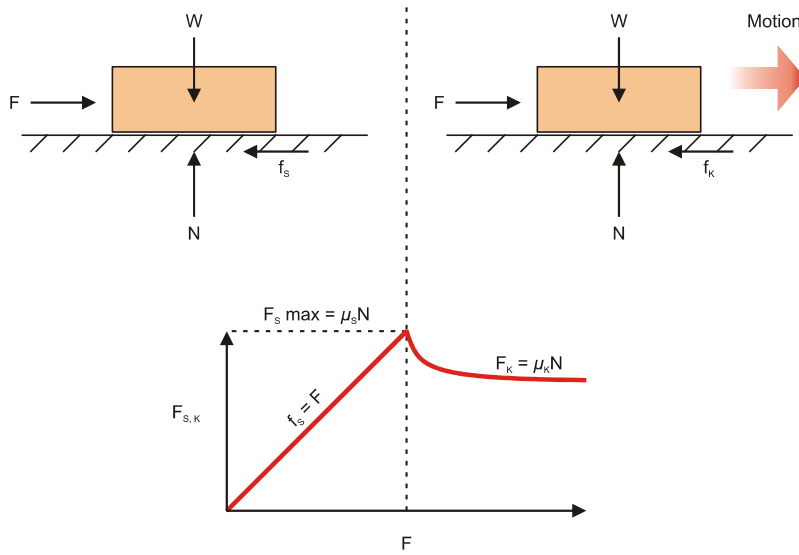

Another Strategy Consideration

Figure 1-9 shows that the SumoBot can exert its highest force of friction just before losing traction. After it starts slipping, it can't push as hard against its opponent because its treads only have kinetic friction to rely on.

Problem: You had to apply 5 lb of force to make an object that weighs 10 lb start to slide on a surface. What is the coefficient of friction?

Solution: Use the μ_s equation and substitute 5 lb for $f_{s, \text{Max}}$ and 10 lb for N.

$$\begin{aligned} \mu_s &= \frac{f_{s, \text{Max}}}{N} \\ &= \frac{5 \text{ lb}}{10 \text{ lb}} \\ &= 0.5 \end{aligned}$$



Coefficients of friction do not have units. A friction force is always equal to the coefficient of friction, multiplied by the normal force. There are no units that need to cancel each other out. For example, if you start with a normal force that's in newtons, and multiply by a coefficient of friction, the result will be a frictional force in newtons.

Problem: It took a 700 g mass (W_1) hanging from this pulley system shown in Figure 1-11 to make a 2100 g mass (W_2) start to slide. Find the coefficient of static friction, μ_s .

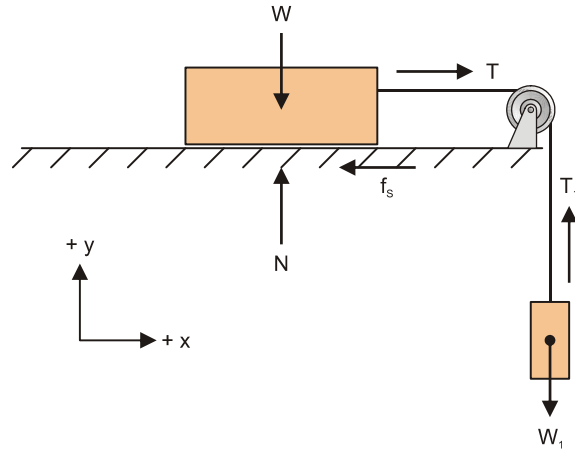

Figure 1-11
Pulley Problem

Tension in the string applies force equal to weight W_1 to the block on the surface.

Solution: If the system is exactly at $T = f_{s,Max}$, nothing is moving yet. From Figure 1-11, we know that T and T_1 are equal and opposite:

$$T = T_1$$

The next step is to draw separate free body diagrams for each object (see Figure 1-12). The sum of the forces for the hanging block should add up to zero:

$$\begin{aligned} \sum F_y &= 0 \\ T_1 - W_1 &= 0 \\ T_1 &= W_1 \end{aligned}$$

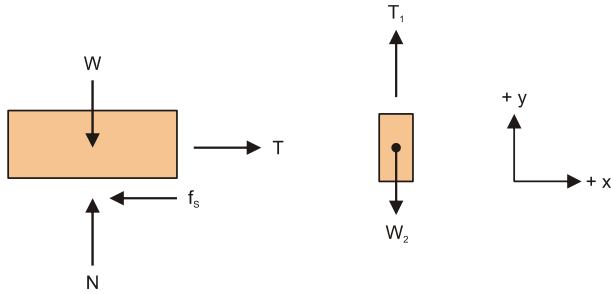

Figure 1-12
Individual Free Body
Diagrams

Since we already know that $T = T_1$, we now know that $T = W_1$. Next, calculate the sum of the forces of the block on the table in both the x and y axis directions.

$$\begin{array}{l} \sum F_y = 0 \\ N - W = 0 \\ N = W \end{array} \qquad \begin{array}{l} \sum F_x = 0 \\ T - f_s = 0 \\ W_1 - f_s = 0 \\ W_1 = f_s \\ f_s = W_1 \end{array}$$

So, our key for solving this puzzle is that the normal force N is equal to the object's weight, and the force of static friction f_s is equal to the weight of the hanging object. We already know the masses of both objects, and we also know that f_s is the weight of W_1 , and N is the weight of W . So, all that's left is to calculate the forces. To solve for this in terms of force, first convert the weights to SI units of kg. Then, convert the masses to newton forces, and finally, plug these values into the equation for the coefficient of kinetic friction.

First, convert to SI units of kg:

$$700\text{g} \times \frac{1\text{kg}}{1000\text{g}} = 0.7\text{kg}$$

$$2100\text{g} \times \frac{1\text{kg}}{1000\text{g}} = 2.1\text{kg}$$

Next, convert to the corresponding units of force (newtons):

$$W = mg$$

$$N = 2.1\text{kg} \times 9.8\text{m/s}^2$$

$$= 20.58\text{N}$$

$$f_s = 0.7\text{kg} \times 9.8\text{m/s}^2$$

$$= 6.86\text{N}$$

Finally, plug these forces into the coefficient of kinetic friction equation and calculate the result:

$$\begin{aligned} \mu_s &= \frac{f_k}{N} \\ &= \frac{6.86\text{N}}{20.58\text{N}} \\ &= 0.333\dots \end{aligned}$$



Why couldn't I have just used the ratio of the masses? For this particular problem on the earth's surface, you can use this shortcut. The ratio of the masses does give you the correct answer, $700/2100 = 0.333\dots$. However, you should always keep in mind that the μ_s and μ_k are ratios of forces. While you won't encounter it in this book, the problems get more complex when they incorporate things like thrust and a body's tendency to rotate. In general, when the problems get more complex, you will have to be strict about the difference between mass and force.

Coefficients of friction make predicting how much force it will take to get something to slide really easy. The same applies for sustained sliding and the coefficient of kinetic friction. In either case, all you have to do is multiply the normal force by the coefficient of friction.

$$f_s = \mu_s \times N \quad \text{and} \quad f_k = \mu_k \times N$$

When the surface is tilting, the normal force takes some extra calculating, but when it's horizontal to the ground, like in Figure 1-8, the normal force is just the object's weight on the surface. The force to start it sliding is the coefficient of friction multiplied by the object's weight, and the force to keep it sliding is the coefficient of kinetic friction multiplied by the object's weight.

$$f_s = \mu_s \times W \quad \text{and} \quad f_k = \mu_k \times W$$

Problem: The coefficient of static friction for two surfaces is 0.1 (pretty slippery). How much force will it take to get a 10 lb weight to start to slide if the contact surfaces are level?

Solution: It takes 1 lb of force to start the object's slide:

$$\begin{aligned}f_s &= \mu_s \times W \\ &= 0.1 \times 10 \text{ lb} \\ &= 1 \text{ lb}\end{aligned}$$

Problem: If you increase the weight from the previous problem to 20 lb, how much force will you need to overcome static friction?

Solution: Twice the weight means you need to apply twice the force.

$$\begin{aligned}f_s &= \mu_s \times W \\ &= 0.1 \times 20 \text{ lb} \\ &= 2 \text{ lb}\end{aligned}$$



This is the reason adding weight to your SumoBot will increase the friction force the sumo ring exerts on it.

Parts and Equipment

A pulley and weight system will be used to test the SumoBot tread's coefficient of friction and response to increased weight. Unless noted, these parts are not included in the SumoBot Robot Competition Kit

- (1) SumoBot (included)
- (1) Sumo ring (included)
- (1) String or fishing line strong enough to suspend both your SumoBots. Length should be approximately 1 m.
- (1) Scale able to measure grams or ounces
- (1) Pulley and attachment hardware
- (1) Disposable plastic cup
- (misc) Assorted weights (nails, nuts, bolts, pennies, fishing sinkers, etc).

Don't worry if you don't happen to have a gram scale or pulley and attachment. Thanks to the popularity of calorie counting, dietary scales can be purchased at most food markets and drug stores for under \$10 (US). Pulleys and mounting hardware are also easy to get from hardware stores for \$5 or less, just ask where to find the sliding door replacement parts. Figure 1-13 shows examples of both pieces of equipment.



Figure 1-13
Example of
Inexpensive Scale
and Pulley



Make sure the pulley turns freely! The calculations assume the pulley and string have no effect on the system. In reality, they always do, so it's important to reduce their effects until they become "negligible" compared to the other forces involved. The string should be light, and the pulley and string together should offer next to no resistance. You may need to experiment with different pulleys. Be creative, and don't limit yourself to door replacement hardware. For example, you can build a home-made pulley with heavy coat hanger wire and an empty thread spool.

Friction Force Calculations and Tests

Figure 1-14 shows the setup you will use to test frictional forces.

- √ Weigh the SumoBot.
- √ Build the system shown in Figure 1-14.

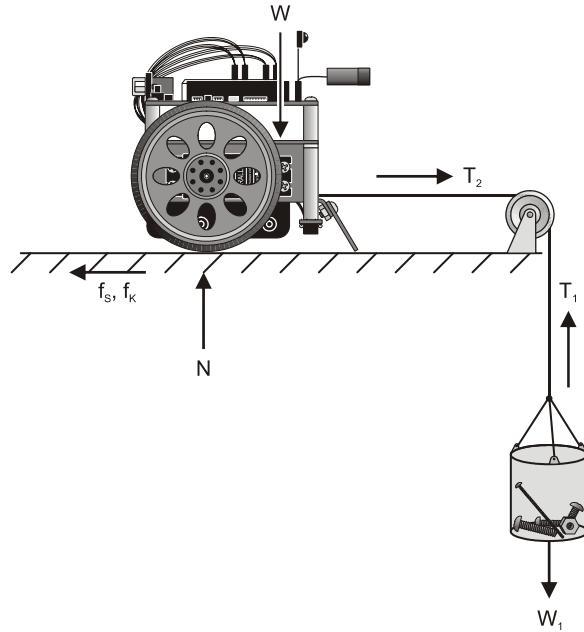

Figure 1-14
Friction Force Test

When you have constructed this setup, follow these steps.

- ✓ Draw free body diagrams and write the equations for Figure 1-14. Use the problem and solution with Figure 1-11 and Figure 1-12 as your guide.
- ✓ Record the SumoBot's weight as $W = \underline{\hspace{2cm}}$.
- ✓ Add weight to the cup until the SumoBot starts to slide.
- ✓ Remove enough weight so that the SumoBot doesn't slide.
- ✓ Add small increments of weight until the SumoBot starts to slide again.
- ✓ Weigh the cup and its contents, and record your value as $W_{1S} = \underline{\hspace{2cm}}$.
- ✓ Remove about 1/3 of the weight from the cup.
- ✓ Push the SumoBot to start it sliding. It should stop. If it doesn't stop, keep removing weight until it does stop after every time you give it a starting push.
- ✓ Add small increments of weight until you can push the SumoBot to get it started, and it keeps sliding slowly. This indicates the applied force has only slightly exceeded the force of kinetic friction.
- ✓ Weigh the cup and contents, and record it as $W_{1K} = \underline{\hspace{2cm}}$.

- √ Use your weights and the equations introduced in this activity to calculate the coefficients of static and kinetic friction for the SumoBot tire treads and the sumo ring surface.
- √ Put the SumoBot on the scale, and add mass until the scale indicates your SumoBot and payload is just under 500 g.
- √ Repeat these tests with your 500 g SumoBot.
- √ Compare the forces of friction the sumo ring exerts on the tire tread with and without payload.
- √ Remove the tire treads and repeat the experiment.

Your Turn

- √ Repeat Activity #1, and test to find out if the position of the payload added to the SumoBot can be adjusted to give it added advantage.
- √ Be creative with testing different materials for tire treads. Try cutting a balloon in half and then stretch it around each tire. How about the material in surgical gloves? Neoprene, broccoli rubber-bands, sections of bicycle innertube, silicone tubing, paint-on urethane, rubber cement?

SUMMARY

This chapter introduced a variety of mechanical adjustments you can make to the SumoBot. Adjusting the plow angle is one important consideration. Managing the pause time between servo pulses is another important consideration because it can result in slower servo motor operation. Frictional forces are yet another important consideration. There are two ways to increase the friction between the SumoBot's tire treads and the competition ring. The first is to increase the SumoBot's weight. Adding mass to get it to the maximum allowed 500 g can make a significant difference. Choosing a tire tread material that features the highest possible coefficient of friction between the tread and ring surfaces is a second way to increase the friction forces. These friction forces are what will make it possible for your SumoBot to push harder against its opponent.

This chapter introduced several experimental approaches along the way. Adjusting the SumoBot's plow involved trial and error. Testing for servo speed involved percent difference calculations. Testing for frictional forces involved designing and building a pulley system to test and quantify forces of static and kinetic friction between the tire tread and sumo ring. The friction forces activity also introduced a number of physics principles including static and kinetic friction and their coefficients. Free body diagrams were also introduced as a way to analyze the sum of the forces acting on an object. Free body diagrams were also applied to the SumoBot to analyze the forces involved in the pulley experiment.

Questions

1. What does the `Reset_Button` routine in `Forward100Pulses.bs2` do?
2. How many servo control pulses does `Forward100Pulses.bs2` send to a servo signal line?
3. How does the `PULSOFF` command control servo speed?
4. How is reducing the left servo speed different from reducing the right servo speed?
5. What sensor considerations have to be made with regards to the maximum time between servo pulses?
6. What's the equation for percent speed reduction when comparing a faster and slower servo?
7. What's the difference between force and mass?
8. What's the SI unit of force?
9. What's the SI unit for acceleration?

10. What's the British Engineering unit of mass?
11. How does force relate to mass and acceleration?
12. What's the acceleration due to gravity in SI units?
13. What is an object's weight in terms of its mass and the earth's gravity?
14. How do you apply a conversion factor to a quantity whose units you want to convert?
15. What's a free body diagram?
16. Should a free body diagram of a block show the surface it's sliding on?
17. What does ΣF_y mean?
18. What is kinetic friction?
19. What is a coefficient of static friction?
20. How do you calculate the coefficient of kinetic friction?
21. What's a normal force?
22. How can different coefficients of frictions indicate different frictional forces, given the same weight?

Exercises

1. Write a block of code that makes your SumoBot travel in a path that curves to the left indefinitely.
2. Modify Forward100Pulses.bs2 so that it makes the SumoBot go forward 200 pulses instead.
3. If a SumoBot's wheel makes 9.25 revolutions in 10 seconds, calculate the wheel's rotational speed in RPM.
4. If a particular piece of code slows the servo's speed from 60 to 50 RPM, calculate the percent speed reduction.
5. Calculate the weight of a 450 g SumoBot in newtons.
6. Calculate the weight of a 475 g SumoBot in newtons.
7. Calculate the SI mass of a SumoBot that weighs 17.12 oz.
8. Calculate the SI mass of a SumoBot that weighs 17.46 oz.
9. Calculate the force it takes to start a 10 lb rubber object sliding along a level concrete sidewalk.
10. Calculate the force it takes to start a 5 kg rubber object sliding along a level concrete sidewalk.
11. Calculate the force it takes to start an 8 oz steel object sliding along a level copper surface.
12. Calculate the force it takes to start a 100 lb block of ice sliding across a frozen lake.

13. It takes 70 lbs of force to start a 100 lb object sliding along a level surface. Calculate the coefficient of static friction between the object and the surface.
14. It takes 28 lb of force to start a 37 lb object sliding along a level surface. Calculate the coefficient of static friction between the object and the surface.
15. It takes 4.9 N of force to start a 1 kg object sliding along a level surface. Calculate the coefficient of static friction between the object and the surface.
16. It takes 9.3 N of force to start a 1 kg object sliding along a level surface. Calculate the coefficient of static friction between the object and the surface.

Projects

1. How much does 40 ms between pulses reduce the likelihood of winning a round compared to 20 ms between pulses. Start by adjusting the plows so that each SumoBot gets the advantage in 5 out of 10 trials. You may want to repeat 20 or 30 trials to be sure the odds are close to 50/50.

Modify Forward100Pulses.bs2 so that the SumoBots' servos turn indefinitely. The trial should then be run long enough to give you a clear idea of which SumoBot will win the round. You will want to see one SumoBot obviously losing ground and getting pushed backwards by the other.

Modify a second version of Forward100Pulses.bs2 so that it runs indefinitely with 40 ms pause times instead of 20 ms pause times. Repeat another 30 trials. How many times did the SumoBot with 20 ms **PAUSE** times win? Is this a significant or negligible increase?

2. How much advantage does a SumoBot with a payload that increases its mass to 500 g have over a SumoBot with no payload? As with Project 1, start with two SumoBots that are equally matched for gaining plow advantage. Use Forward100Pulses.bs2 in each SumoBot. This time, the programs should have identical **PAUSE** durations. Add a payload to one of the SumoBots to increase its mass to about 500 g. Repeat 30 trials and compare to the initial advantage. How many times did the SumoBot with more mass win? Again, is this a significant or negligible increase.

Chapter #2: EEPROM Tricks and Program Tips

The BASIC Stamp's EEPROM is a great tool for storing values that you don't want to get erased. After you've stored a value to EEPROM, it doesn't matter whether the power has been turned off or the Reset button has been pressed and released. The value will still be there (in EEPROM) when your program needs it.

This chapter introduces some of the techniques that will be reused in later chapters for things like self-calibrating sensors (Chapter 3) and datalogging a sumo round (Chapter 5). This chapter also takes a closer look at how a PBASIC program can make the Reset button function as an on/off switch for sumo wrestling mode. When used with a pushbutton, speaker, and LED, the EEPROM programming techniques make it possible to select between many different modes of operation, which can come in handy for strategy changes on the fly.

This chapter also introduces some conventions that will allow you to use just a couple of variables to do many different jobs. These conventions, along with some program design and organization strategies, will make it possible for you to mix and match old code into future application programs.

EEPROM AND PROGRAM MANAGEMENT

DATA directives are great tools for setting aside bytes, words, and clusters of bytes for later use in the program. **DATA** directives can pre-store values in EEPROM, and they can also give the beginning of a group of reserved EEPROM bytes a unique name that your program can then use to always find the particular bytes it needs to do its jobs. Regardless of whether you're logging data, calibrating sensors, or toggling between wrestling modes, if you've arranged your EEPROM with **DATA** directives that have *Symbol* names, it will make retrieving and storing all the values a snap.

Following common code conventions also yields a variety of benefits. For example, if your subroutines make effective use of temporary variables for counting and manipulating values, you'll be able to copy subroutines from old programs into new programs and get them working with minimal trouble-shooting. Another feature that helps when combining old and new programs is maintaining clearly defined sections, like EEPROM Data, Variables, Main Routine, Subroutines, and so on. When integrating parts of older programs into current programs, going through section by section greatly simplifies the job.

As the SumoBot programs get larger and more complex, both good EEPROM management and strict adherence to code conventions will make large and complex programs seem easy, or at least, not nearly as hard as they might look.

ACTIVITY #1: A CLOSER LOOK AT THE EEPROM

The optional *symbol* names that you can use to precede **DATA** directives are powerful programming tools that make storing and accessing values much easier. Especially when you're dealing with more than one list of stored values, *symbol* names are indispensable. This activity starts by examining the relationship between a **DATA** directive's *symbol* name and the values the **DATA** directive pre-writes to EEPROM when the program downloads.

This activity also introduces techniques you can use to store new values in an EEPROM byte to track how many times the Reset button has been pressed and released. In addition, distinguishing between odd and even values as well as odd and even numbers of resets is introduced.

Symbol Names, Addresses, and EEPROM Bytes

The BASIC Stamp 2's EEPROM is 2048 bytes. Each byte has an address that can store either program tokens or values you tell it to store. When a program is downloaded to EEPROM, it occupies the highest addresses, starting at address 2047, 2046, 2045, etc. If a program is 500 bytes, it will occupy memory from EEPROM addresses 2047 to 1548. That leaves EEPROM addresses 0 to 1547 free for storing data.

You can use **DATA** directives to pre-store values in available EEPROM bytes (those not being used for program storage) at the time a program is downloaded. Once the program is running, EEPROM bytes are not like variables in that they cannot be manipulated directly, but **READ** commands can copy values stored in EEPROM to variables. After the values are copied to variables, they can be manipulated, used for comparisons, etc, and then **WRITE** commands can copy the values stored in those variables back to EEPROM.

The program SymbolNamesVsAddressContents.bs2 declares several **DATA** directives:

```
Numbers      DATA    7, 20, 11, 2, 80
RunStatus    DATA    0
UndefData    DATA    (20)
Alphabet     DATA    "ABCDEFG"
```

Figure 2-1 shows what the **DATA** directives will store in the EEPROM bytes with addresses 0 to 31. It also points out the first byte address of each **DATA** directive with *Symbol* names. Keep in mind that the BASIC Stamp Editor makes each **DATA** directive's *Symbol* name a constant equal to the address of the first byte in the **DATA** directive. That way, you can always use the *Symbol* name to reference the first *DataItem* in a given **DATA** directive.

When the program is downloaded, the values 7, 20, 11, 2, and 80 get stored in EEPROM bytes at addresses 0, 1, 2, 3, and 4. The BASIC Stamp Editor assigns the **Numbers** *Symbol* name the constant value 0. The **RunStatus** **DATA** directive stores the value 0 in the EEPROM byte at address 5, so **RunStatus** becomes the constant value 5.

UndefData sets aside 20 bytes of EEPROM for use by the program. No values are written to those EEPROM bytes, and if values are already stored there, they won't be overwritten. As with the rest of the **DATA** directives, **UndefData** can now be used in place of the number 6. Since **UndefData** reserves 20 bytes, the **Alphabet** **DATA** directive doesn't start until byte 26 in EEPROM. **Alphabet** becomes the constant value 26, and "A" is stored at address 26, "B" at address 27, and so on.

Figure 2-1 EEPROM Addresses 0 to 32

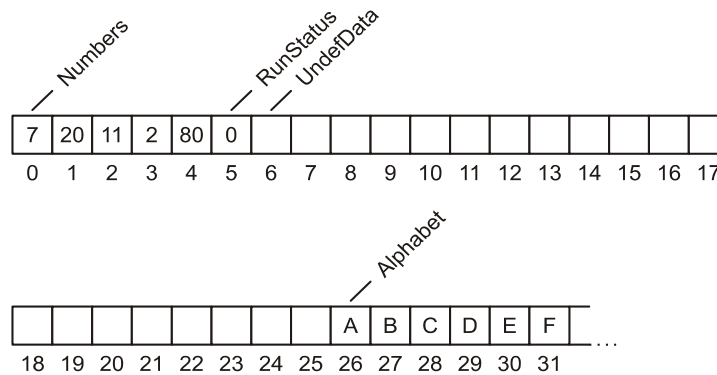



EEPROM stands for Electrically Erasable Reprogrammable Read Only Memory.

EEPROM memory is nonvolatile. That means, you can store a value in EEPROM, disconnect power, then reconnect power, and the values you stored will still be there.

Compile-time vs. Run-time - DATA directives are processed when the BASIC Stamp Editor compiles the program. In other words, **DATA** directives are processed at compile-time. The **WRITE** command can change the values in EEPROM while the program is running. That's why **WRITE** commands are said to be run-time commands.

Example Program - SymbolNamesVsAddressContents.bs2

This example program helps demonstrate the distinction between the **DATA** directive *Symbol* names in and the actual data that gets stored in EEPROM bytes.

- √ Review SymbolNamesVsAddressContents.bs2, and predict what it's going to display before you run the program.
- √ Enter, save, and run SymbolNamesVsAddressContents.bs2
- √ Compare the output in the Debug Terminal to your predictions, and reconcile any differences.

```
' Applied Robotics with the SumoBot - SymbolNamesVsAddressContents.bs2
' {$STAMP BS2}
' {$PBASIC 2.5}

Numbers      DATA    7, 20, 11, 2, 80
RunStatus    DATA    0
UndefData    DATA    (20)
Alphabet      DATA    "ABCDEFGG"

temp         VAR      Word
counter      VAR      Byte

DEBUG "Address of Numbers.....", DEC Numbers, CR

DEBUG "Value stored at Numbers....."
READ Numbers, temp
DEBUG DEC temp, CR

DEBUG "Value at (Numbers + 1)....."
READ Numbers + 1, temp
DEBUG DEC temp, CR, CR

DEBUG "Address of RunStatus.....", DEC RunStatus, CR
DEBUG "Value stored at RunStatus..."
```



```

READ RunStatus, temp
DEBUG DEC temp, CR

DEBUG "Address of UndefData.....", DEC UndefData, CR, CR

DEBUG "Address of Alphabet.....", DEC Alphabet, CR
DEBUG "Values stored....."
FOR counter = 0 TO 6
  READ Alphabet + counter, temp
  DEBUG temp
  PAUSE 200
NEXT
END

```

Your Turn - Examining EEPROM Symbol name Values

Figure 2-2 shows the Memory Map window for SymbolNamesVsAddressContents.bs2.

- ✓ Click the BASIC Stamp Editor's Run menu, then select Memory Map. The window that appears should resemble the one shown in Figure 2-2.

Figure 2-2 Memory Map

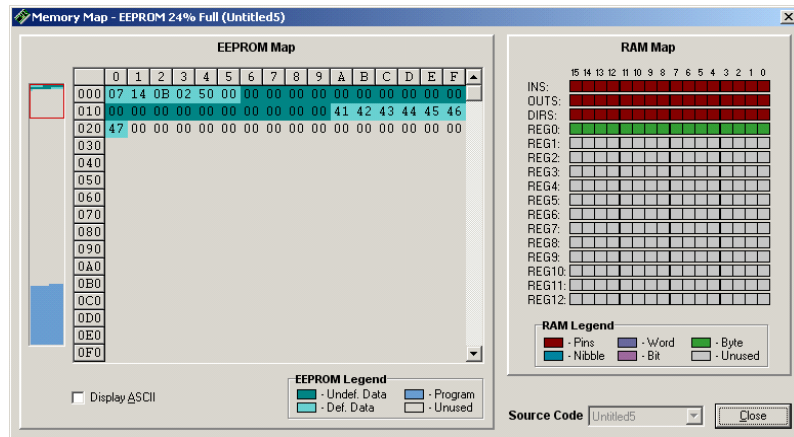

The values of the EEPROM bytes and the addresses along the top and side of the EEPROM map are all displayed as hexadecimal (base-16) numbers. Hexadecimal counts like this: 0, 1, 2, 3, 4, 5, 6, 7, 8, 9, A, B, C, D, E, F, 10, 11, 12... To convert from hexadecimal to decimal, multiply the rightmost digit by $16^0 = 1$, then the 2nd digit from

the right by $16^1 = 16$, then the third digit from the right by $16^2 = 256$, and so on. Add up all the products, and you've got your conversion. For example,

$$\begin{aligned}
 7C3 &= (3 \times 16^0) + (C \times 16^1) + (7 \times 16^2) && \textit{place values} \\
 &= (3 \times 1) + (C \times 16) + (7 \times 256) && \textit{power expansion} \\
 &= (3 \times 1) + (12 \times 16) + (7 \times 256) && \textit{hex digit value} \\
 &= 3 + 192 + 1792 \\
 &= 1987
 \end{aligned}$$

The first five bytes in the EEPROM map are the hexadecimal equivalents of list of **DataItems** from the **Numbers DATA** directive: 7, 20, 11, 2, and 80. The fifth byte is 0 from the **RunStatus DATA** directive. Notice on your monitor that the next 20 bytes have a darker green color code corresponding to undefined data. These are the EEPROM bytes that were reserved by the **UndefData DATA** directive. The final list of digits starts at hexadecimal address 1A (decimal-26). These are the ASCII codes for "A", "B", "C", etc.

- √ To view the list of characters in the last **DATA** directive, click the Display ASCII checkbox in the Memory map window.
- √ Look for the ABCDEFG in the Memory Map.

DATA directives build sequentially from EEPROM address 0 upward. However, you can use the optional **@Address** operator to specify a particular starting address for each **DATA** directive.

- √ Use the optional **@Address** operator to move **RunStatus** to the 10th byte in EEPROM like this:

```
RunStatus DATA @10, 0
```

- √ View the Memory Map again and note the effect.
- √ Try the example program with this modification. Because of the way the optional **symbol** names are used, it should make no difference to the way the program behaves.

You can also use the **word** modifier to store values larger than 255. The **word** modifier stores the value in EEPROM as 2 bytes. It works with the **DATA** directive as well as the **READ** and **WRITE** commands.

- ✓ Modify the `RunStatus DATA` directive like this:

```
RunStatus DATA @10, Word 500
```

- ✓ Modify the command that reads the EEPROM byte at the `RunStatus` address like this:

```
READ RunStatus, Word temp
```

- ✓ Test the program to make sure it can retrieve and display 500.
- ✓ Check the Memory Map and verify that the `RunStatus DATA` directive sets aside 2 bytes instead of 1.

Changing EEPROM Values Between Resets

Let's take a closer look at how an EEPROM byte can be used to track the number of times the SumoBot's Reset button has been pressed and released. This technique can also be applied to counting the number of times the power to the BASIC Stamp has been turned off and back on. You can just as easily insert the `READ` and `WRITE` commands from the next example program into an `IF . . . THEN` statement and count sensor events.



EEPROM is not a replacement for RAM. EEPROM bytes can certainly be used to store values, count events, and so on. However, the EEPROM on the BASIC Stamp 2 is limited to 10-million rewrites. In contrast, variables, which reference values stored in the BASIC Stamp's RAM memory, do not have a limitation on the number of times you can rewrite the values they store.

If your BASIC Stamp modifies a single byte in EEPROM once a minute, that EEPROM byte will wear out in between 19 and 20 years. At once per second, the EEPROM byte will wear out in around 4 months.

This `EepromCounter DATA` directive from the next example program stores a 0 to an EEPROM byte when the program is downloaded. The *Symbol* name `EepromCounter` becomes a constant for the address of that byte.

```
EepromCounter DATA 0
```

A byte variable will be used to manipulate a copy of the EEPROM value.

```
temp VAR Byte
```

The program can then use the `READ` command to fetch the value stored in the EEPROM byte whose address is `EepromCounter`, and copy it to the `temp` variable.

```
READ EepromCounter, temp
```

To make the program count the number of consecutive resets, simply add 1 to the value of `temp` and write it back to the EEPROM byte at the `EepromCounter` address. Next time the program starts, the value the `READ` command fetches will be higher by 1.

```
temp = temp + 1  
  
WRITE EepromCounter, temp
```

The program can then make decisions based on the value of the `temp` variable. To simplify things, the next example program subtracts 1 from `temp` before analyzing it with the `IF...THEN` statement. Subtracting 1 from `temp` is not necessary, it just makes the Your Turn section a little easier to follow.

```
temp = temp - 1  
  
IF temp = 0 THEN  
  DEBUG "Since download, you have", CR,  
        "pressed Reset ", DEC temp,  
        " times.", CR  
ELSE  
  DEBUG CR$RX, 11, "...", DEC temp,  
        " times.", CR  
ENDIF
```

Example Program: ResetButtonCounter.bs2

This program displays the number of times you have pressed and released the SumoBot's Reset button after the program was downloaded.

- ✓ Enter, save, and run `ResetButtonCounter.bs2`.
- ✓ Watch the Debug Terminal as you repeatedly press/release the SumoBot's Reset button.

```
' Applied Robotics with the SumoBot - ResetButtonCounter.bs2  
  
' {$STAMP BS2}  
' {$PBASIC 2.5}  
  
EepromCounter DATA 0  
  
temp VAR Byte  
  
READ EepromCounter, temp
```

```

temp = temp + 1

WRITE EepromCounter, temp

temp = temp - 1

IF temp = 0 THEN
  DEBUG "Since download, you have", CR,
        "pressed Reset ", DEC temp,
        " times.", CR
ELSE
  DEBUG CRSRX, 11, "...", DEC temp,
        " times.", CR
ENDIF

END

```

Your Turn - Distinguishing Odd from Even

You can determine whether the Reset button has been pressed/released an odd or even number of times by examining the `temp` variable as a binary number. When a variable counts up in binary, the rightmost binary bit (1 or 0) changes every time. Here is an example:

Decimal	Binary
0	%0000
1	%0001
2	%0010
3	%0011
4	%0100
5	%0101
6	%0110
7	%0111

Aside from the fact that it changes every time, notice that the rightmost bit is always 1 for odd numbers and 0 for even numbers. If you want your program to take action based on whether a value is odd or even, you'll need to access this rightmost binary bit and use it in `IF . . . THEN` statements.

PBASIC has the `.BIT` (pronounced "dot-bit") operator for accessing the individual binary values in a variable. The rightmost binary value, is accessed with `.BIT0`. The second

binary value from the right is accessed with `.BIT1`; the third binary value is accessed with `.BIT2`, and so on.

Here is an `IF...THEN` statement you can use to determine whether the value of `temp` is odd or even in `ResetButtonCounter.bs2`:

```
IF temp.BIT0 = 0 THEN
  DEBUG DEC temp, " is even.", CR
ELSE
  DEBUG DEC temp, " is odd.", CR
ENDIF
```

- √ Save `ResetButtonCounter` as `ResetButtonCounterYourTurn.bs2`
- √ Insert the odd/even `IF...THEN` statement just before the `END` command in the program.
- √ Run the program, and verify that it correctly identifies each successive value of `temp` as odd or even.

ACTIVITY #2: USING AND REUSING VARIABLES

The next example program demonstrates how you can do many different tasks with three variables. It will prompt you to enter a threshold value, after which, it will prompt you to enter up to 20 more values. To enter your values, click the Transmit windowpane shown in Figure 2-3. Then type each value and press the enter key. When you are done entering values, press the 0 (zero) key, then press Enter. The program will then ask you if you want to compare the values to the threshold you entered. If you respond by pressing the "y" key, the program will display all the values you entered and compare them to the threshold value you entered.

Figure 2-3 Debug Terminal Transmit and Receive Windowpanes

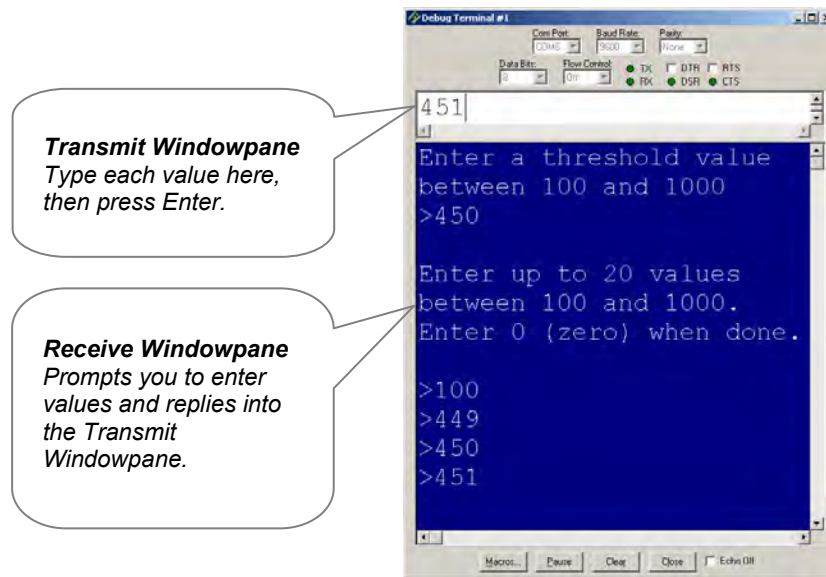

Illustrating Many Jobs with a Few Variables

The `temp` and `counter` variables get used and re-used in the next example program. In later example programs they will be used and re-used by many different subroutines. The `temp` variable is first used in a `DEBUG IN` command to get a threshold variable from the Debug Terminal's Transmit windowpane.

```
' Get threshold value and store it in EEPROM
DEBUG CLS,
      "Enter a threshold value", CR,
      "between 100 and 1000", CR,
      ">"

DEBUG IN DEC temp
WRITE Threshold, Word temp
```

Next, the `temp` variable is used to get successive values from the Debug Terminal and store each in EEPROM. This is also the first (but not the last) time in the program that the `counter` variable is used as a loop counter.

```

DEBUG CR,
  "Enter up to 20 values", CR,
  "between 100 and 1000", CR,
  "Press 0 (zero) when done", CR,
  ">"

counter = 0
DO UNTIL counter >= 40 OR temp = 0

  DEBUGIN DEC temp
  WRITE Values + counter, Word temp
  counter = counter + 2
  DEBUG ">"

LOOP

```

The **temp** variable is then used to get a character from the Debug Terminal's Transmit windowpane and use it to make a decision.

```

' Display & compare values? (y/n)
DEBUG CR, "Compare values to ", CR,
  "threshold? (y/n)", CR,
  ">"

DEBUGIN temp

' Display and compare values
IF temp = "y" OR temp = "Y" THEN

```

Finally, **temp** is used to store successive values that get fetched from EEPROM. In this case, **counter** is re-used as a loop counter, and a third variable, **compare**, is used to store the threshold value for comparison.

```

' Display and compare values
IF temp = "y" OR temp = "Y" THEN

  DEBUG CR,
    "          Threshold", CR,
    "Value          Comparison", CR,
    "-----", CR
  counter = 0
  READ Threshold, Word compare

  DO UNTIL counter >= 40 OR temp = 0

    READ Values + counter, Word temp

```



```

DEBUG CRSRX, 0, DEC5 temp, CRSRX, 12
IF temp > compare THEN
  DEBUG "greater than"
ELSEIF temp < compare THEN
  DEBUG "less than"
ELSE
  DEBUG "equal to"
ENDIF
DEBUG CR
counter = counter + 2

LOOP

ENDIF

```

Example Program: ThreeVariablesManyJobs.bs2

- ✓ Enter, save, and run ThreeVariablesManyJobs.bs2.
- ✓ Try feeding the program the same values shown in Figure 2-3 first. Then re-run the program and use your own values.
- ✓ Review the program. Pay special attention to the different kinds of jobs the program does and how it uses and reuses `temp` and `counter` so many times.

```

' Applied Robotics with the SumoBot - ThreeVariablesManyJobs.bs2
' {$STAMP BS2}
' {$PBASIC 2.5}

' Variable Declarations

counter      VAR      Byte
temp        VAR      Word
compare     VAR      Word

' Set aside EEPROM storage space

Values      DATA    (40)
Threshold   DATA    Word 0

' Get threshold value and store it in EEPROM

DEBUG CLS,
      "Enter a threshold value", CR,
      "between 100 and 1000", CR,
      ">"

DEBUGIN DEC temp
WRITE Threshold, Word temp

```

```

' Get values and store them to EEPROM

DEBUG CR,
  "Enter up to 20 values", CR,
  "between 100 and 1000", CR,
  "Press 0 (zero) when done", CR,
  ">"

counter = 0
DO UNTIL counter >= 40 OR temp = 0

  DEBUGIN DEC temp
  WRITE Values + counter, Word temp
  counter = counter + 2
  DEBUG ">"

LOOP

' Display & compare values? (y/n)
DEBUG CR, "Compare values to ", CR,
  "threshold? (y/n)", CR,
  ">"

DEBUGIN temp

' Display and compare values
IF temp = "y" OR temp = "Y" THEN

  DEBUG CR,
    "          Threshold", CR,
    "Value          Comparison", CR,
    "-----  -----", CR
  counter = 0
  READ Threshold, Word compare

  DO UNTIL counter >= 40 OR temp = 0

    READ Values + counter, Word temp
    DEBUG CRSRX, 0, DEC5 temp, CRSRX, 12
    IF temp > compare THEN
      DEBUG "greater than"
    ELSEIF temp < compare THEN
      DEBUG "less than"
    ELSE
      DEBUG "equal to"
    ENDIF
    DEBUG CR
    counter = counter + 2
  
```

```

LOOP
ENDIF
DEBUG CR, "All done!"
END

```

ACTIVITY #3: PROGRAM ON/OFF WITH RESET

It's really handy to be able to start and halt a sumo wrestling program by pressing and releasing the SumoBot's Reset button. This technique was first introduced in Chapter 3 of the SumoBot book. It makes it possible to press and release the Reset button to toggle between two separate program modes: wrestle, and wait for reset.

Reset Subroutine for the New Program Design

The new `Reset` subroutine will still depend on an EEPROM byte with the `Symbol` name `RunStatus`. This `DATA` directive will write 0 to the `RunStatus` address when the program is downloaded.

```

' -----[ EEPROM Data ]-----
RunStatus      DATA      0              ' Run status EEPROM byte

```

The `Reset` routine from the SumoBot text was a code block in the program's Initialization section. The programs in this text will instead call a subroutine named `Reset` from the Initialization routine.

```

' -----[ Initialization ]-----
GOSUB Reset                ' Wait for Reset press/release
GOSUB Start_Delay          ' 5 Second delay

' -----[ Main Routine ]-----

ResetTest:
    DEBUG CR, "Done!"      ' Verify we made it to main.
END

```

Here is the new `Reset` subroutine. It uses the odd/even number technique introduced in Activity #1 of this chapter. In this subroutine, if `temp` is odd (after 1 has been added to it), it displays the "Press/release Reset button" message, and then ends the program. If

`temp` is even, it displays "Program running..." and returns the program to initialization and onward from there.

```
' -----[ Subroutine - Reset ]-----
Reset:

  READ RunStatus, temp           ' Byte @RunStatus -> temp
  temp = temp + 1                ' Increment temp
  WRITE RunStatus, temp          ' Store new value for next time

  IF (temp.BIT0 = 1) THEN        ' Examine temp.BIT0
    DEBUG CLS, "Press/release Reset", CR, ' 1 -> end, 0 -> keep going
    "button..."
  END
  ELSE
    DEBUG CR, "Program running..."
  ENDIF

RETURN
```

If the program has just been downloaded, the `DATA` directive causes a 0 to be written to the `RunStatus` address. Then, `READ RunStatus, temp` copies the value 0 from the EEPROM byte at the `RunStatus` address to the `temp` variable. `temp = temp + 1` adds 1 to `temp`. The command `WRITE RunStatus, temp` stores this 1 back to the EEPROM byte at the `RunStatus` address. Since `temp.BIT0` is 1, the subroutine displays the message "Press/release Reset button...". Then, the program ends, which in turn causes the BASIC Stamp goes into low power mode.

At this point, there is a 1 in the EEPROM byte at the `RunStatus` address. When you press and release the Reset button, `READ RunStatus, temp` fetches that 1 and copies it to the `temp` variable. `temp = temp + 1` changes that 1 to a 2, and `WRITE RunStatus, temp` writes that 2 back to EEPROM. The `IF...THEN` statement does not end the program this time. Since `temp` is now an even number, `temp.BIT0` stores a 0. As a result, the `IF...THEN` statement instead displays the message "Program running...". After that, the `RETURN` statement sends the program back to the Initialization routine, where it calls the next subroutine, then moves on to the Main Routine.

If you press/release the Reset button a third time, it starts again by fetching the 2 from the `RunStatus` EEPROM byte, adds 1 to make it 3, then stores it back to EEPROM, and ends the program with the "Press/release Reset button..." message. If you press/release the Reset button a fourth time, it fetches the 3, adds 1 to make it 4, stores it, and

continues to the rest of the program. As you keep pressing the Reset button, the odd/even pattern continues, as does the program's alternation between the "Press/release Reset..." and "Program running..." messages.

Example Program: TestResetButton.bs2

- √ Enter, save, and download TestResetButton.bs2.
- √ Verify that it displays the "Press/release reset button..." message and ends the program.
- √ Press/release the Reset button. Verify that the program displays the message "Program running...", beeps 5 times, then displays the message "Done!".
- √ Press/release the Reset button a second time.
- √ Verify that the program behaves the same as it did when you first downloaded it.
- √ Press/release the Reset button a third time, and verify that it behaves the same way it did the first time you did it.
- √ Keep repeating a few more times to make sure the odd/even pattern continues.

```
' -----[ Title ]-----
' Applied Robotics with the SumoBot - TestResetButton.bs2

' {$STAMP BS2}                               ' Target = BASIC Stamp 2
' {$PBASIC 2.5}                             ' Language = PBASIC 2.5

' -----[ I/O Definitions ]-----
LedSpeaker      PIN      5                    ' P5 controls LED & speaker

' -----[ Variables ]-----
temp            VAR      Word                ' Temporary variable
counter        VAR      Byte                ' Loop counting variable.

' -----[ EEPROM Data ]-----
RunStatus      DATA    0                    ' Run status EEPROM byte

' -----[ Initialization ]-----
GOSUB Reset    ' Wait for Reset press/release
GOSUB Start_Delay ' 5 Second delay

' -----[ Main Routine ]-----

ResetTest:

  DEBUG CR, "Done!" ' Verify we made it to main.
```

```

END

' -----[ Subroutine - Reset ]-----
Reset:

READ RunStatus, temp           ' Byte @RunStatus -> temp
temp = temp + 1                ' Increment temp
WRITE RunStatus, temp          ' Store new value for next time

IF (temp.BIT0 = 1) THEN        ' Examine temp.BIT0
  DEBUG CLS, "Press/release Reset", CR, ' 1 -> end, 0 -> keep going
  "button..."
END
ELSE
  DEBUG CR, "Program running..."
ENDIF

RETURN

' -----[ Subroutine - Start_Delay ]-----
Start_Delay:

FOR counter = 1 TO 5           ' 5 beeps, 1/second
  PAUSE 900
  FREQOUT LedSpeaker, 100, 3000
NEXT

RETURN

```

Your Turn

- √ Try modifying the program so that it displays the number of times you have pressed and released the Reset button.

ACTIVITY #4: PUSHBUTTON, LED, AND SPEAKER

The LED and speaker can be used as status indicators. Primarily, the beeping and LED blinking helps you know when the SumoBot is doing its 5 second countdown. These indicators are also useful for trouble-shooting SumoBot behavior problems. The single pushbutton can be used along with the indicators to adjust the SumoBot's behavior between sumo rounds and even select between different operation modes.

Building and Testing the LED and Piezospeaker Circuits

The LED and piezospeaker circuit shown in Figure 2-4 is an interesting combination of the individual circuits. Instead of connecting the LED and piezospeaker to separate I/O pins, both circuits are connected to the same I/O pin. This circuit can come in handy, especially if you are running low on available I/O pins. Keep in mind that this circuit will always light the LED when the speaker plays a tone. Likewise, if the LED is turned on/off, the speaker will make a clicking sound. The clicking sound when the LED changes state can actually be useful for "hearing" what's going on with the status indicator LED during debugging sessions.

- √ Remove all existing circuits from the SumoBot's white breadboard space.
- √ Build the LED circuit shown in Figure 2-4 on the SumoBot's breadboard.

Parts List

- (2) Jumper wires
- (1) LED - red
- (1) Resistor - 470 Ω (yellow-violet-brown)
- (1) Piezospeaker

Figure 2-4 Parallel LED and Piezospeaker Circuits

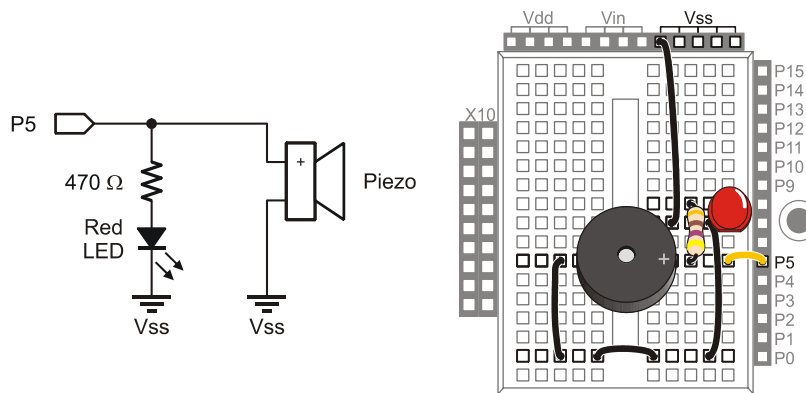

This circuit should be tested to make sure your programs can make the LED turn on/off as well as make the piezospeaker chime a few notes. In the next example program, you will see this `PIN` directive:

LedSpeaker PIN 5

After declaring this **PIN** directive, the name **LedSpeaker** can be used as either an input or an output. The BASIC Stamp Editor examines each command with **LedSpeaker** as an argument and decides whether to send an output to the pin or store the input value sensed by the pin. When used in the **PIN** argument of commands like **HIGH**, **LOW**, **TOGGLE**, or **FREQOUT**, the BASIC Stamp Editor treats the I/O pin as an output.

Example Program: TestLedSpeaker.bs2

- √ Enter, save, and run TestLedSpeaker.bs2.
- √ Verify that it makes the LED rapidly turn on/off several times.
- √ The piezospeaker should then play a brief tone.
- √ If either of the components do not behave as expected, check your circuit and program for errors.



Remember Each time the LED changes state, the speaker will make a clicking noise, and each time the speaker plays, the LED will turn on.

If the LED doesn't turn on, remember from *What's a Microcontroller* and *Robotics with the Boe-Bot* that the LED is a 1-way current valve. The LED's shorter cathode lead should be connected to Vss; otherwise current will not flow through it.

```
' -----[ Title ]-----
' Applied Robotics with the SumoBot - TestLedSpeaker.bs2
' Tests the LED and piezospeaker circuit connected to P5 by flashing
' the LED on/off 15 times, then playing a tone on the speaker.

' {$STAMP BS2}                               ' Target = BASIC Stamp 2
' {$PBASIC 2.5}                               ' Language = PBASIC 2.5

' -----[ I/O Definitions ]-----
LedSpeaker    PIN    5                        ' LED/speaker connected to P5

' -----[ Variables ]-----
counter       VAR    Byte                      ' Loop counting variable

' -----[ Initialization ]-----
DEBUG CLS, "LED flashing..."                 ' Prompt to check LED

' -----[ Main Routine ]-----
```



```

FOR counter = 1 TO 30                                ' Flash LED on/off 15 times
  TOGGLE LedSpeaker
  PAUSE 250
NEXT

DEBUG CR, "Speaker playing tone"                    ' Prompt to listen for tone

FREQOUT LedSpeaker, 2000, 3000                      ' Play 3 kHz tone for 2 seconds

DEBUG CR, "All done."                               ' Prompt user - program finished

END

```

Your Turn - Playing Musical Notes

The **LOOKUP** command can be handy for storing brief sequences of musical notes.

- √ Save a copy of the program as TestLedSpeakerYourTurn.bs2.
- √ Add the variable declaration **note VAR Word**.
- √ Replace the single **FREQOUT** command in TestLedSpeaker.bs2 with this **FOR...NEXT** loop.

```

FOR counter = 0 TO 7
  LOOKUP counter, [1046, 1175, 1319,
                  1397, 1580, 1760,
                  1976, 2093], note
  FREQOUT 5, 500, note
  PAUSE 25
NEXT

```

- √ Run the program and listen to the results.
- √ Save the modified program.

Building and Testing the Pushbutton Circuit

Figure 2-5 shows the pushbutton circuit connected to P6. When the pushbutton is not pressed, P6 senses ground through the 470 Ω and 10 k Ω resistors, and stores a 0 in its **IN6** input register. If the pushbutton is pressed, P6 senses the direct connection to Vdd, and stores a 1 in **IN6**.

- √ Build the circuit shown in Figure 2-5.

Parts List

- (1) Jumper wire
- (1) LED - red
- (1) 1 Resistor - 470 Ω (yellow-violet-brown)
- (1) 1 Resistor - 10 k Ω (brown-black-orange)

Figure 2-5 Pushbutton Circuit added to LED and Piezospeaker

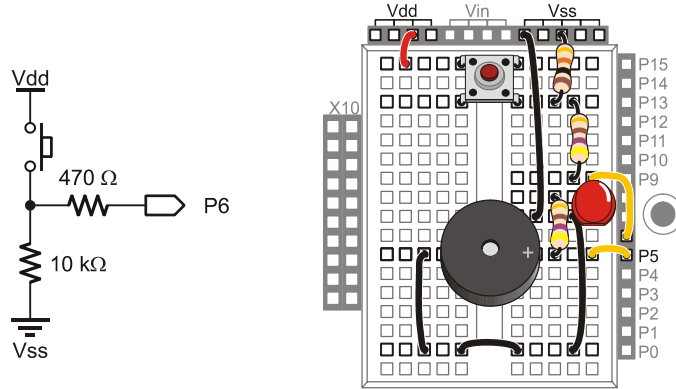

A `PIN` directive can also be used for P6:

```
pBSense      PIN      6
```

Now the name `pBSense` can be used in `DEBUG` commands to display whichever pushbutton state the I/O pin senses. `pBSense` can also be used in `IF...THEN` and other conditional statements that might need to make decisions based on the state of the pushbutton. In other words, you can use `DEBUG BIN1 pBSense` or `IF pBSense = ...` just as you would use `DEBUG BIN1 IN6` and `IF IN6 = ...`. Either way, the decision is actually made based on the value stored in the BASIC Stamps `IN6` input register, which is where the 1 or 0 sensed by the I/O pin is actually stored. Nonetheless, using a `PIN` symbol like `pBSense` just makes programs more convenient to write and easier to read.

The next example program should display a series of zeros while the pushbutton on the breadboard is not pressed, and a series of ones while it is pressed. Figure 2-6 shows an example.

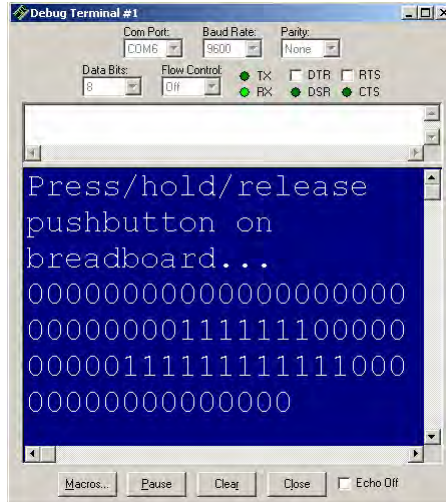

Figure 2-6
Debug Terminal
Displaying the State
of pbSense

*Zeros repeat every
1/10 second while the
button is not pressed.
Ones repeat while
the button is pressed.*

Example Program: TestPushbutton.bs2

- ✓ Enter, save, and run TestPushButton.bs2.
- ✓ The Debug Terminal should display a message, and then start displaying a series of repeating zeros every 1/10 second.
- ✓ Watch the Debug Terminal as you press, hold, and release the pushbutton. While you were holding the pushbutton down, the Debug Terminal should have displayed a series of ones instead of zeros.



Troubleshooting if the Debug Terminal doesn't display 1s while you have the button pressed, check your circuit. Also check your circuit if the program displays 1s while the pushbutton is not pressed.

If the program starts over again instead of continuing to display binary values, make sure to press/hold/release the button on the breadboard, not the Reset button on the SumoBot PCB.

```
' -----[ Title ]-----
' Applied Robotics with the SumoBot - TestPushButton.bs2
' Displays the state of the pushbutton sensed by P6 in the Debug Terminal.

' {$STAMP BS2}                               ' Target = BASIC Stamp 2
' {$PBASIC 2.5}                               ' Language = PBASIC 2.5

' -----[ I/O Definitions ]-----
```

```

pbSense      PIN      6              ' Pushbutton connected to P6

' -----[ Initialization ]-----
DEBUG CLS, "Press/hold/release" , CR,      ' PROMPT press/release pushbutton
      "pushbutton on", CR,
      "breadboard...", CR

' -----[ Main Routine ]-----
DO
      ' DO...LOOP repeats indefinitely

      DEBUG BIN1 pbSense      ' Display state of pbSense (IN6)
      PAUSE 100              ' Delay for slower PCs

LOOP

```

Your Turn - Controlling the LED with the Pushbutton

After adding the `LedSpeaker PIN` directive to this program, you can make the LED flash on/off while you hold down the pushbutton. All it takes is an `IF...THEN` added to the `DO...LOOP` in the main routine.

- ✓ Save a copy of the program as TestPushButtonYourTurn.bs2.
- ✓ Add the `PIN` directive `LedSpeaker PIN 5`.
- ✓ Replace the `DO...LOOP` in the Main Routine with this one:

```

DO
      ' DO...LOOP repeats indefinitely

      DEBUG BIN1 pbSense      ' Display state of pbSense (IN6)

      IF pbSense = 1 THEN      ' Flash LED if pbSense = 1
          TOGGLE LedSpeaker
      ELSE
          LOW LedSpeaker      ' Otherwise, keep pin low
      ENDIF

      PAUSE 100              ' Delay for slower PCs

LOOP

```

- ✓ Run the program and verify that you now have pushbutton control of the LED.
- ✓ Save the modified program.
- ✓ For fun, try modifying the program so that it plays a list of notes when you press/release the button.

ACTIVITY #5: PUSHBUTTON PROGRAM MODE SELECTION

In some competitions, changing strategy between sumo rounds could make a big difference in your SumoBot's standing. This activity introduces a simple technique you can use to select the SumoBot's mode of operation based on cues from the speaker.

Selecting the Mode

In the next example program, you can enter a mode selection by pressing and holding the pushbutton while you press and release the Reset button. After releasing the Reset button, the program will beep once, then twice, then three times, and so on up to five times. To select mode one, let go of the pushbutton after the speaker has beeped once. To select mode two, keep holding the pushbutton, and instead let go after the speaker has beeped twice. For mode three, wait for three beeps before letting go, and so on.

This program uses an EEPROM byte with a different *Symbol* name - `ModeSelect`. This is another value that is initialized to zero when the program is downloaded, but `WRITE` commands will change this value during run-time.

```
' -----[ EEPROM Data ]-----
ModeSelect      DATA      0          ' Program select byte
```

This `IF...THEN` statement in the Initialization routine checks to see if the pushbutton is pressed. If it is, the `Mode_Select` subroutine gets called. Otherwise, the program just moves on to the next command.

```
' -----[ Initialization ]-----
IF pbSense = 1 THEN GOSUB Mode_Select ' Call Mode_Select subroutine
```

The `Mode_Select` subroutine uses a pair of nested `FOR...NEXT` loops. The outer loop uses the `temp` variable to count from 1 to 5. The inner loop counts from 1 to `temp`. The first time through the outer loop, `temp` is 1, so the inner loop beeps the speaker once. The inner loop is followed by a 1-second `PAUSE`, after which, an `IF...THEN` statement checks the pushbutton. If the pushbutton has been released, the `IF...THEN` statement writes the value 1 stored by `temp` to the `ModeSelect` EEPROM byte and exits the outer loop.

If the pushbutton has not yet been released, the outer loop repeats. The second time through the `FOR...NEXT` loop, `temp` will be 2. So, the inner loop beeps twice. After another 1 second `PAUSE`, the outer loop again checks the pushbutton. If the pushbutton

```

CASE 1
  DEBUG "one"
CASE 2
  DEBUG "two"
CASE 3
  DEBUG "three"
CASE 4
  DEBUG "four"
CASE 5
  DEBUG "five"
ENDSELECT
ENDIF

END                                     ' End program

```

**Strategy Tip**

Your SumoBot programs could use this mode argument any number of ways. For example, it might use `SELECT...CASE` to choose between different kinds of navigation routines that search for opponents. On the other hand, it might just select something like a frequency to use to make the SumoBot's IR object detectors more nearsighted, or a different number of pulses for turning in place in the ring.

Example Program: PushbuttonMode.bs2

- ✓ Enter, save, and run PushbuttonMode.bs2.
- ✓ Press and hold the pushbutton as you press and release the Reset Button.
- ✓ Wait until the speaker beeps three consecutive times before letting go of the pushbutton.
- ✓ Verify that the Debug Terminal indicates mode 3 has been selected.
- ✓ Repeat and try selecting different modes.

```

' -----[ Title ]-----
' Applied Robotics with the SumoBot - PushbuttonMode.bs2

' {$STAMP BS2}                               ' Target = BASIC Stamp 2
' {$PBASIC 2.5}                               ' Language = PBASIC 2.5

' -----[ I/O Definitions ]-----

pbSense      PIN      6                       ' Pushbutton connected to P6
LedSpeaker   PIN      5                       ' LED/speaker connected to P5

' -----[ Variables ]-----

temp          VAR      Word                   ' Temporary variable
counter       VAR      Byte                   ' Loop counting variable.

```

```

' -----[ EEPROM Data ]-----
ModeSelect      DATA      0              ' Program

' -----[ Initialization ]-----
IF pbSense = 1 THEN GOSUB Mode_Select      ' Call Mode_Select subroutine

' -----[ Main Routine ]-----
READ ModeSelect, temp                      ' Fetch mode from EEPROM

IF temp = 0 THEN                            ' Mode = 0 -> no mode selected
  DEBUG CR, "No mode selected",
  CR, "Hold down pushbutton",
  CR, "then press/release",
  CR, "Reset button."
ELSE                                         ' mode <> 0 -> display mode
  DEBUG CR, CR, "Operating in mode ", CR    ' Mode Message
  SELECT temp                               ' Select mode value to display
    CASE 1
      DEBUG "one"
    CASE 2
      DEBUG "two"
    CASE 3
      DEBUG "three"
    CASE 4
      DEBUG "four"
    CASE 5
      DEBUG "five"
  ENDSELECT
ENDIF

END                                          ' End program

' -----[ Subroutine - Mode_Select ]-----

' Selects mode of operation

Mode_Select:

  DEBUG CR,                                ' Display user instructions
  CR, "Release pushbutton after",
  CR, "number of beeps to select",
  CR, "mode (1 to 5).".

  FOR temp = 1 TO 5                          ' Cycle 5 times
    FOR counter = 1 TO temp                  ' temp beeps, 1/second
      PAUSE 100
      FREQOUT LedSpeaker, 100, 4000
    
```



```

NEXT
PAUSE 1000
IF pbSense = 0 THEN
    WRITE ModeSelect, temp
    EXIT
ENDIF
NEXT

RETURN
' 1 second between beeps
' Button released?
' Record mode to EEPROM
' Exit FOR...NEXT loop

```

Your Turn

- √ Try modifying PushbuttonMode.bs2 so that you can choose different forward distances to make the SumoBot travel in case you have to repeat plow adjustments or other tests.

ACTIVITY #6: INTEGRATING PROGRAMS

PBASIC application programs typically contain the following sections:

- Title or heading information
- Compiler definitions
- I/O Definitions
- Constant declarations
- Variable declarations
- EEPROM Data
- Initialization
- Main Routine
- Subroutines

There are several reasons for all these sections. First, it helps prevent larger programs from getting out of hand by keeping them well organized. Second, it makes the program more readable. Third, it helps keep the elements in each program modular.

Modular program components are really important. Why? Because it makes it possible to re-use components from a previous project in new projects. For example, let's say you move on from SumoBots to a complex maze solving contest. If you developed lots of valuable techniques with your SumoBot, you may want to copy selected subroutines into the maze solving robot's program. If your code follows conventions to keep it modular, you'll be able to do this with minimal hassle.

One of the most important ingredients of modular programs is keeping the same naming conventions for variables. For example, in this book, `temp` is a temporary variable that is used to receive and manipulate stored information and sensor measurements. After decisions are made based on `temp` in one subroutine, `temp` is always free to be used in the next subroutine. The same applies to the `counter` variable. When it's done counting in a loop in one subroutine, it is free to count in a different loop in the next subroutine.

In this activity, you will combine two programs that were developed in this chapter: `TestResetButton.bs2` from Activity #3, and `PushbuttonMode.bs2` from Activity #5. Because both programs follow the same rules for sectioning and temporary variable use, they will be really easy to combine. Both of these programs have clearly defined sections (I/O Definitions, Variables, EEPROM Data, Subroutines and so on). Both programs also follow the same naming conventions for reusable variables like `temp` and `counter`. As you will see, these are two key ingredients for making all of your test and application programs building blocks for future programs.

Combining the Reset and Pushbutton Mode Programs

The first step to combining `TestResetButton.bs2` and `PushbuttonMode.bs2` is to save a copy of one of the programs. We'll start by saving `TestResetButton.bs2` as `ResetAndStartMode.bs2`. Then, we'll copy the elements from `PushbuttonMode.bs2` that were not already in `TestResetButton.bs2`. For example, `TestResetButton.bs2` already had the `LedSpeaker PIN` directive, but not the `pbSense PIN` directive. So, the `pbSense PIN` directive will be copied from `PushbuttonMode.bs2` to the new `ResetAndStartMode.bs2`. After repeating this process for each section (Variables, EEPROM Data, Initialization, etc), we'll have a complete program that performs both the reset-start function and the mode-select function.

- √ Open `TestResetButton.bs2` and save it as `ResetStartAndMode.bs2`
- √ Open `PushbuttonMode.bs2`.
- √ Copy the `pbSense PIN` directive from the I/O definitions section in `PushbuttonMode.bs2`, and paste it into the I/O definitions section in `ResetAndStartMode.bs2`.
- √ Copy the `ModeSelect DATA` directive from the EEPROM Data section in `PushbuttonMode.bs2`, and paste it to the EEPROM Data section in `ResetAndStartMode.bs2`.

While all the steps up to this point were purely mechanical, the Initialization section will take some thought. There are several options. You can put the **IF...THEN** statement from PushbuttonMode.bs2's initialization as the first, second or third step. To make the decision, think about how the program would work if the **IF...THEN** is the first step. Then, consider how it would work differently if it was the second step, and so on. An advantage to having it as the first step is that you can set the mode regardless of whether the main program is going to run or not, so we'll try that.

Example Program: ResetAndStartMode.bs2

- √ Copy the **IF pbSense = 1 THEN GOSUB Mode_Select** from the Initialization section in PushbuttonMode.bs2, and paste it to the Initialization section in ResetAndStartMode.bs2.
- √ Copy the **ModeTest** routine from the main routine in PushbuttonMode.bs2, and paste it *to the beginning* of the Main Routine in ResetAndStartMode.bs2. The **ModeTest** routine should come before the **ResetTest** routine.



Be careful with END commands in the main routine. Both the ModeTest and ResetTest routines contain END statements. If you forget to delete the END command at the end of the ModeTest routine, you'll never get through the ResetTest routine..

- √ If you have not already done so, delete the **END** that comes before the **ResetTest** routine.
- √ Copy the **Mode_Select** subroutine from the Subroutines section in PushbuttonMode.bs2, and paste it to the Subroutines section in ResetAndStartMode.bs2. Pasting it as the last subroutine in ResetAndStartMode.bs2 is fine.
- √ Update the Title section so that it has the current program name and a correct program description.
- √ Compare your program to ResetAndStartMode.bs2 shown below.

```
' -----[ Title ]-----
' ---> Updated <---
' Applied Robotics with the SumoBot - ResetAndStartMode.bs2
' Program constructed by copying and pasting code from
' PushbuttonMode.bs2 into TestResetButton.bs2.

' {$STAMP BS2}                ' Target = BASIC Stamp 2
' {$PBASIC 2.5}              ' Language = PBASIC 2.5
```

```

' -----[ I/O Definitions ]-----
LedSpeaker      PIN      5              ' P5 controls LED & speaker
' ---> Pasted from PushbuttonMode.bs2 <---
pbSense         PIN      6              ' Pushbutton connected to P6
' -----[ Variables ]-----
temp            VAR      Word           ' Temporary variable
counter         VAR      Byte          ' Loop counting variable.
' -----[ EEPROM Data ]-----
RunStatus       DATA    0              ' Run status EEPROM byte
' ---> Pasted from PushbuttonMode.bs2 <---
ModeSelect      DATA    0              ' Program
' -----[ Initialization ]-----
' ---> Pasted from PushbuttonMode.bs2 <---
IF pbSense = 1 THEN GOSUB Mode_Select  ' Call Mode_Select subroutine
GOSUB Reset                                           ' Wait for Reset press/release
GOSUB Start_Delay                                     ' 5 Second delay
' -----[ Main Routine ]-----
' ---> Pasted from PushbuttonMode.bs2 (ModeTest routine)<---
ModeTest:
  READ ModeSelect, temp                               ' Fetch mode from EEPROM
  IF temp = 0 THEN                                   ' Mode = 0 -> no mode selected
    DEBUG CR, "No mode selected",
      CR, "Hold down pushbutton",
      CR, "then press/release",
      CR, "Reset button."
  ELSE                                               ' mode <> 0 -> display mode
    DEBUG CR, CR, "Operating in mode ", CR          ' Mode Message
    SELECT temp                                       ' Select mode value to display
      CASE 1
        DEBUG "one"
      CASE 2
        DEBUG "two"
      CASE 3
        DEBUG "three"
      CASE 4
        DEBUG "four"
      CASE 5

```

```

        DEBUG "five"
    ENDSELECT
ENDIF

ResetTest:
    DEBUG CR, "Done!"           ' Verify we made it to main.
    END

' -----[ Subroutine - Reset ]-----
Reset:

    READ RunStatus, temp       ' Byte @RunStatus -> temp
    temp = temp + 1           ' Increment temp
    WRITE RunStatus, temp     ' Store new value for next time

    IF (temp.BIT0 = 1) THEN    ' Examine temp.BIT0
        DEBUG CLS, "Press/release Reset", CR, ' 1 -> end, 0 -> keep going
            "button..."
    END
    ELSE
        DEBUG CR, "Program running..."
    ENDIF

    RETURN

' -----[ Subroutine - Start_Delay ]-----
Start_Delay:

    FOR counter = 1 TO 5      ' 5 beeps, 1/second
        PAUSE 900
        FREQOUT LedSpeaker, 100, 3000
    NEXT

    RETURN

' ---> Pasted from PushbuttonMode.bs2 (Mode_Select subroutine) <---
' -----[ Subroutine - Mode_Select ]-----
' Selects mode of operation

Mode_Select:

    DEBUG CR,                 ' Display user instructions
        CR, "Release pushbutton after",
        CR, "number of beeps to select",
        CR, "mode (1 to 5)."

    FOR temp = 1 TO 5        ' Cycle 5 times
        FOR counter = 1 TO temp ' temp beeps, 1/second

```

```

    PAUSE 100
    FREQOUT LedSpeaker, 100, 4000
NEXT
    PAUSE 1000                                ' 1 second between beeps
    IF pbSense = 0 THEN                        ' Button released?
        WRITE ModeSelect, temp                ' Record mode to EEPROM
        EXIT                                  ' Exit FOR...NEXT loop
    ENDIF
NEXT
RETURN

```

Your Turn - Testing the New Program

There should be two ways to set the program mode. The first is to hold down the pushbutton as you download the program. The other is to hold the pushbutton down as you press and release the Reset button. Since EEPROM memory is used to store the mode, it's nonvolatile, meaning that disconnecting power or pressing and releasing Reset cannot erase the value. You can also change the mode value by simply holding down the pushbutton as you press and release Reset again.

- √ Hold down the pushbutton (not the Reset button!) as you download ResetAndStartMode.bs2 to your SumoBot.
- √ Keep holding the button down until the SumoBot makes three consecutive beeps, then let go.
- √ Press and release the Reset button.
- √ Verify that the SumoBot is operating in mode three.
- √ Don't hold the pushbutton down as you press and release the Reset button a few more times to verify that the SumoBot retains the mode three setting.
- √ Press and hold the pushbutton, then press/release the Reset button.
- √ Keep holding the pushbutton until after four consecutive beeps, then let go.
- √ Press and release the Reset button again, and verify that the SumoBot has now retained mode four.
- √ Download the program one more time, and verify that the mode setting has been erased (because the `ModeSelect DATA` directive writes a 0 to `ModeSelect`).
- √ Try also changing `ModeSelect DATA 0` to just `ModeSelect DATA`. That way, the program won't overwrite the mode you chose whenever you download it.

You pretty much always have the choice of making the `DATA` directive pre-store values in EEPROM, or just having them reserve the space.

SUMMARY

This chapter introduced a variety of EEPROM and program management techniques. EEPROM management focused on declaring and naming **DATA** directives for all EEPROM bytes and groups of bytes used in the program. Techniques for counting resets were introduced for both toggling between different SumoBot program modes and for selecting from a list of program modes. Programming focused on adhering to code conventions for the sake of making large programs easy to build from smaller programs in your library.

A **DATA** directive is a compile-time command that pre-stores values to EEPROM when the program is downloaded. **DATA** directives can also be used to organize the portion of EEPROM used for storing values. An optional *Symbol* name preceding the **DATA** keyword can be used to give a meaningful name to the starting address of each group of bytes. Since this Symbol name represents an address in EEPROM it simplifies **READ** and **WRITE** operations in programs that maintain more than one group of EEPROM *DataItems*.

A procedure was introduced for merging components of smaller programs into larger programs. It depended on keeping programs organized in common sections: Title, Compiler Directives, I/O Definitions, Constants, Variables, EEPROM Data, Initialization, Main Routine, and Subroutines. It also depended on using a common naming convention for temporary and counting variables.

Questions

1. How many bytes are in the BASIC Stamp 2's EEPROM memory?
2. If your program took 20 bytes, what would be the addresses of the bytes that store the program?
3. If your program takes 1024 bytes, how many bytes are available for EEPROM storage of values?
4. If your program has a **DATA** directive `values DATA 1, 2, 3`, and `DEBUG DEC values` displays the value 100, what does that mean?
5. What does EEPROM stand for?
6. What's does compile-time mean?
7. What number system does the BASIC Stamp's EEPROM map use to display the byte addresses and contents?
8. What is the hexadecimal number for decimal-15?

9. What is the decimal number for hexadecimal-E?
10. What PBASIC operator allows you to examine individual bits in larger variables?
11. What does the **IF...THEN** statement in the **Reset** subroutine do if the **temp** variable is even?
12. What variable stores the binary 1/0 values sensed by **pbSense**?
13. In **PushbuttonMode.bs2**, what how is **temp** used?
14. Why are PBASIC programs separated into sections?
15. What's the advantage in using the optional *symbol* name for all **DATA** directives?

Exercises

1. Write a **DATA** directive that stores the prime numbers between 0 and 100. Write a routine to display all the values.
2. Calculate the decimal equivalent of hexadecimal-3FF.
3. Write a routine that displays each bit in a byte variable.
4. Modify the **SELECT...CASE** statement in **PushbuttonMode.bs2** so that you can select forward travel in different distances with each mode.
5. Write a line of code that sets aside 100 consecutive EEPROM bytes as undefended data.
6. Write a routine that captures two values from the Debug Terminal's Transmit windowpane and compares them.

Projects

1. Use the techniques from Activity #5 to make an adjustable version of **Forward100Pulses.bs2** from Chapter 1, Activity #1. Make it so you can select between 6 different distances ranging from 100 to 500 in steps of 100 and infinite loop mode.
2. Modify the **Reset** subroutine so that you can use the Reset button to select from four different modes of operation. Test this routine in a modified version of **Pushbuttonmode.bs2** that does not require the pushbutton.

Chapter #3: Sensor Management

3

The SumoBot's sensors are critical components to its performance in the Sumo ring. To get the most out of the sensors that come in the SumoBot Robot Competition Kit, it's important to have a better understanding of how the sensors work. Understanding each sensor's strengths, weaknesses and pitfalls will be important ingredients to your SumoBot strategies. It's also important to know how to write code to calibrate sensors, as well as code to make them self-calibrating.

Preventing sensor measurements from taking too much time is important, as is preventing them from taking too much memory. Beyond that, storing each sensor's reading in a way that makes it easier for the program to make decisions can help you translate your strategies into PBASIC programs. Sensor subroutines should also follow the coding conventions introduced in the previous chapter. That way, you can mix and match different sensors on the same robot with minimal difficulty integrating them into your sumo wrestling code.

SENSORS - TESTING, TUNING, AND STORING THE RESULTS

This chapter will take a closer look at how the SumoBot's IR detectors work. In addition to the basics, reliability testing, IR interference testing, and procedures for tuning IR receiver sensitivity will be introduced. Side-mounted IR object detectors will also be added to give your SumoBot peripheral vision.

This chapter will also take a closer look at how QTIs work and how PBASIC code for making the QTIs self-calibrating works. In addition, techniques that limit the QTI measurement times to prevent servo slowdown are also introduced.

By the end of the chapter, your SumoBot will be sporting four IR detectors, two QTIs, and a pushbutton. You'll find that some of the techniques for storing sensor results that this chapter introduces are very useful for future navigation decisions. Techniques introduced in Chapter 2 for the naming of temporary variables and placing code in sections will be revisited here as all the sensor readings are combined into a single program.

ACTIVITY #1: TESTING AND TUNING INFRARED OBJECT DETECTORS

Figure 3-1 shows the SumoBot and the locations of its front left and front right infrared (IR) object detectors. The IR LED and receivers were plugged into headers X8 and X9 and tested in the Chapter 4 of the *SumoBot Manual*. Testing and tuning these object detectors can make a huge difference in your SumoBot's performance in the competition ring. This activity introduces four important tests you should perform on your SumoBot's IR detectors before starting a match:

1. Basic functionality
2. Sources of IR interference
3. Electrical continuity
4. Effective range

Figure 3-1 Front IR Object Detectors in the X8/X9 Headers

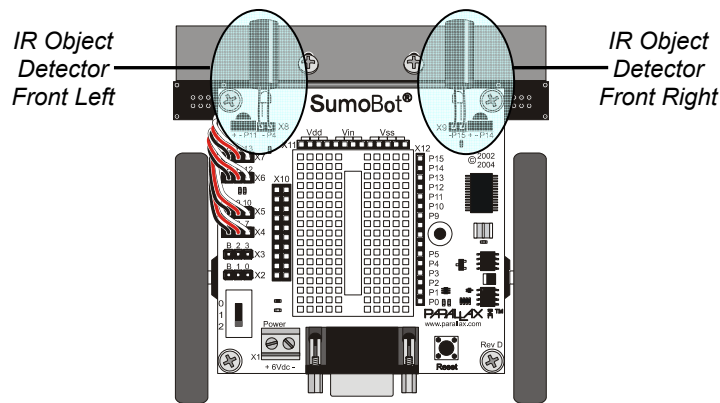

Parts Required

(1) SumoBot with QTIs and IR detectors mounted. See SumoBot text, Chapter 4 for instructions.

IR Object Detection

Figure 3-2 shows schematics of the left and right IR object detectors. The left detector is connected to header X8, and the right to X9. Each schematic is separated into three columns. The leftmost column shows the connections that are built into the SumoBot printed circuit board (PCB). The middle column shows the silk-screened markings next

to the header. The right column shows the components that you plugged into the header, the IR receiver, and shielded IR LED.

Figure 3-2 IR Object Detection Circuits

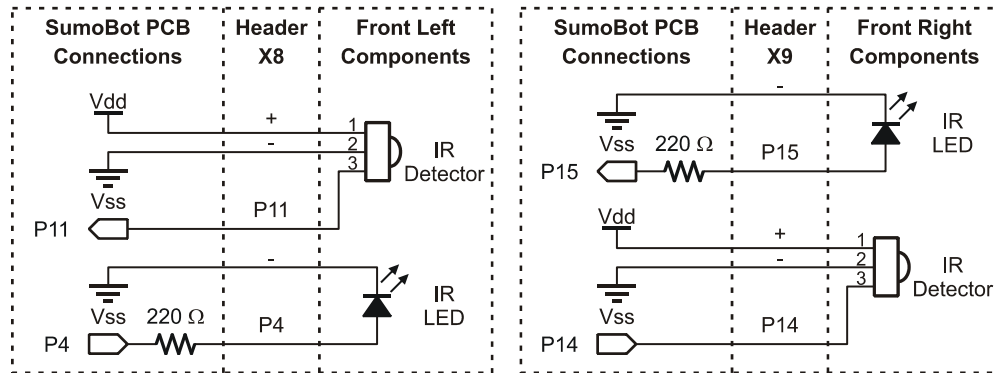

Testing the front left IR detector involves sending a 38500 kHz signal to P4, then immediately storing the value sensed at P11 in a bit variable. Here is an example of some PBASIC code that will do this:

```

irLF      VAR      Bit
.
.
.
FREQOUT 4, 1, 38500
irLF = IN11

```



The SumoBot's IR receivers are designed to send a low signal to the BASIC Stamp whenever they detect infrared light flashing on/off at frequencies in the neighborhood of 38.5 kHz. 38.5 kHz is 38,500 on/off cycles per second. The IR receivers send a high signal if they do not see IR flashing on/off at that rate.

To detect objects, the SumoBot's BASIC Stamp has to use its IR LED headlights to shine infrared flashing on/off at 38,500 times per second. If the infrared is reflected off an object and bounces back, the IR receiver will detect it.

The command `FREQOUT Pin, Duration, 38500` actually sends a harmonic signal at 38.5 kHz. The IR receivers can't really tell the difference between a fundamental and a harmonic. To learn more about this and other IR object detection techniques, see Chapters 7 and 8 in *Robotics with the Boe-Bot*.

If the IR receiver is sending 5 V to P11, it means it doesn't see any reflected infrared. If this is the case, the BASIC Stamp stores the value 1 in the P11 input register bit `IN11`. If the IR receiver does detect infrared reflected off some object, it will send 0 V to P11. While P11 senses 0 V, `IN11` stores a 0. The problem is, the IR receiver only sends that 0 V for a fraction of a millisecond after the `FREQOUT` command stops. After the IR receiver's output rebounds to 5 V, `IN11` stores a 1 again. That's why the command `irLF = IN11` must come immediately after the `FREQOUT` command. Even though `IN11` will return to 1 by the time the next PBASIC command gets executed, the value 0 gets safely stored in the `irLF` (short for infrared-left-front) variable for as long as the program needs it.

A more formal way to write the IR detection routine is to use a `PIN` directive, and give P11 a name like `IrSenseLF`, which stands for infrared-sensor-left-front. Likewise, you can give P4 a name, like `IrLedLF`, which is short for infrared-light-emitting-diode-left-front. You can then use these pin names in place of the 4 and the `IN11`. In addition, give the value 38500 a constant name, like `IrFreq`. Your code will then look like this:

```

IrLedLF      PIN      4
IrSenseLF    PIN      11
.
.
.
IrFreq       CON      38500
.
.
.
irLF         VAR      Bit
.
.
.
FREQOUT IrLedLF, 1, IrFreq
irLF = IrSenseLF

```

The `PIN` directive has lots of advantages. For example, imagine you have a program that uses the same I/O pin in 20 different places. What if you disconnect the circuit from the I/O pin you were using and connect it to a different I/O pin? Instead of replacing 20 different references to the I/O pin, simply update the number in the `PIN` directive, and the program is fixed. Another `PIN` directive advantage is that the BASIC Stamp Editor looks at each command and decides whether you are using the I/O pin as an output or an input.

The IR receivers are active-low, meaning they send a low signal to signify the active condition (IR signal detected). When your SumoBot is dealing with lots of sensors, the programming and trouble shooting will all be easier if they are all active-high.

The problem is this: `irLF` stores a 0 when an object is detected and a 1 when it is not. Instead, we want `irLF` to store the opposite, a 1 when an object is detected, and a 0 when it is not. This problem is solved by placing the invert bits operator, a tilde (~), in front of `IrSenseLF` in the statement:

```
irLF = ~IrSenseLF
```

Now, if `IrSenseLF` stores a 1, the ~ operator inverts this value to 0 before copying it to `irLF`. Likewise, if `IrSenseLF` stores a 0, the ~ operator inverts it to 1 before storing it in `irLF`.

Testing the IR Detectors

The next example program tests the IR object detectors for basic functionality. When the IR object detectors connected to the X8 and X9 headers are pointed straight ahead, their detection pattern look roughly like Figure 3-3. While running `TestFrontIrObjectDetectors.bs2`, the Debug Terminal should display a 1 when an object is detected, and a 0 when it's not. In the figure, the SumoBot has detected an opponent with the right detector, but not with its left. In later activities, you will experiment with navigation corrections to get the opponent centered and engaged head-on.

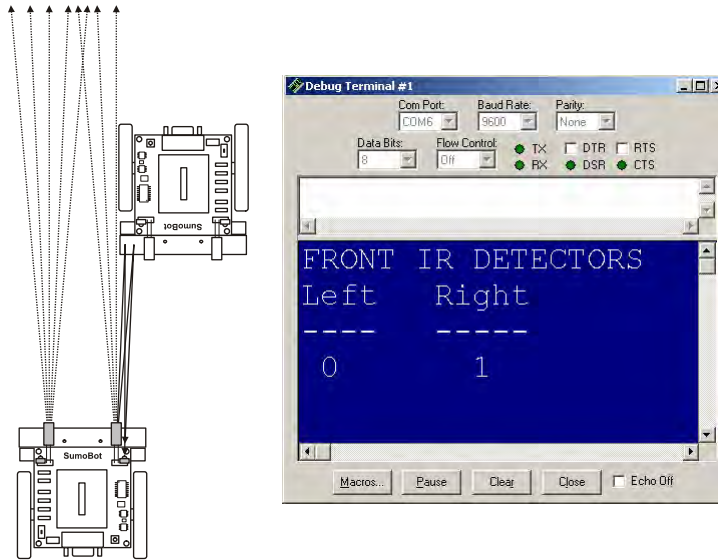

Figure 3-3
Opponent Detected
at Front-Right

Example Program - TestFrontIrObjectDetectors.bs2

- ✓ Enter, save, and run TestFrontIrObjectDetectors.bs2.
- ✓ Point your SumoBot away from nearby objects. It may actually detect walls as far as 1 to 2 m away. If your detectors are pointing slightly downward, they will also detect the floor, so point the IR LEDs level to the ground, or even slightly upward if needed.
- ✓ Pass your other SumoBot across your test SumoBot's field of vision at a distance of 10 cm. As you do so, starting from left to right, the readings displayed by the Debug Terminal should be 00, 10, 11, 01, 00.

Trouble-Shooting



If 0 is always displayed, check your wiring and program for errors. Make sure your IR LED is not connected with the wrong polarity. Like normal LEDs, the IR LED is a 1-way current valve, and won't emit infrared light if it's plugged in the wrong way. The shorter of the IR LEDs two pins is the cathode terminal, and it should be connected to Vss. If the pins have been trimmed, you can still identify the cathode terminal by locating the flat spot on the LED's clear plastic case. The pin closest to this flat spot is the cathode terminal.

If 1 is always displayed, try pointing your SumoBot in a direction where there are no objects for several meters. If this doesn't work, also check your wiring and program.

Your Turn - Headlight Adjustments

A small change in the direction the SumoBot's IR LEDs are pointing can make a huge difference in its performance. Remember this when testing the competition code at the end of chapter 4 and the datalogging code at the end of Chapter 5. You will probably find yourself adjusting the direction each IR LED points to get the most consistent detection of your opponent.

For the programs in this text, you should start by pointing the IR LEDs *straight ahead*. Pointing the IR LEDs outward can cause the SumoBot to not realize its opponent is straight in front of it because both IR detectors can't see the opponent at the same time. Pointing the IR LEDs inward can result in the SumoBot thinking the opponent is on its front right, when it is in fact on its front left (and visa-versa). Pointing the IR LEDs upward can result in missing an opponent because the headlights are too high.

One adjustment that can be useful is pointing the IR LEDs slightly downward. The angle should be very slight, certainly not more than 5° below horizontal when viewed from the side. When viewed from the top, the IR LEDs should still be pointing straight ahead, there should be no detectable angle outward or inward.

The slight downward angle can be helpful during the part of a round when the SumoBots are pushing against each other. As they push against each other, sometimes both the SumoBots tip upward briefly. At this moment, if the IR LEDs are not tilting slightly down, it can cause even the SumoBot with the advantage to think its opponent is no longer in front of it. Its program might cause it to change from lunging forward to executing a search pattern, which will in turn cause it to give up its advantage.

- √ With TestFrontIrObjectDetectors.bs2, try pushing the SumoBots against each other to create the symptom just described.
- √ Try to tilt the IR LEDs so that it still sees its opponent if it has the plow advantage (Chapter 1, Activity #1), and so that it loses sight of its opponent if it has the plow disadvantage.
- √ Make a note to yourself to revisit this issue during Chapter 4, Activity #6 and also during Chapter 5, Activity #4.

Certain SumoBots may benefit from very slight outward or inward adjustments as well. This again will be a trail and error experiment you can try in Chapter 4, Activity #6 and also during Chapter 5, Activity #4.

Testing for Sources of IR Interference

Fluorescent lights have a part called a ballast built into them. The ballast is responsible for amplifying the AC outlet voltage to a level that is high enough to make the gas inside the glass tube fluoresce and emit light. Some of the electronic ballasts built into more recently manufactured fluorescent lights can be a problem for the infrared detectors. These ballasts cause the light to send off a signal that the IR receiver is sensitive to. When the IR receiver detects this signal, it sends a low signal to the BASIC Stamp, and the BASIC Stamp thinks an object has been detected when it really hasn't. To make matters more confusing, certain other devices like handheld remotes and video cameras or camcorders can also send out interfering signals.

It's best to stage your SumoBot competitions well away from fluorescent lights and other devices that broadcast this kind of interference, either by turning off the light, or moving the competition ring. With a few modifications to `TestFrontIrObjectDetectors.bs2`, you can then use your SumoBot as an IR interference sniffer. To test and make sure the SumoBot can indeed detect IR interferences, simply run the unmodified version of `TestFrontIrObjecDetectors.bs2` in the other SumoBot. Point the two SumoBots at each other, and the one running the modified code should sense the IR from the other SumoBot and sound the alarm.

The key to making an IR interference sniffer is to not send out any IR before checking the IR receiver's output. In other words, remove the `FREQOUT` commands to the `IrLedLeft` and `IrLedRight` pins. If the SumoBot's infrared headlights are off, but it the receivers are still detecting an infrared signal in the neighborhood of 38.5 kHz, it must mean it's coming from a source of IR interference. So, sound the alarm.

The next example program started as `TestFrontIrObjectDetectors.bs2`. The two most important changes that convert `TestFrontObjectDetectors.bs2` to `IrInterferenceSniffer.bs2` are:

- (1) removing the `FREQOUT` commands, and
- (2) adding code that makes sounds if either of the IR receivers tell the BASIC Stamp they detect an infrared signal.

```

' -----[ Main Routine ]-----
DO                                     ' DO...LOOP repeats indefinitely

  irLF = ~IrSenseLF                   ' Save IR receiver outputs
  irRF = ~IrSenseRF                   ' Sound alarm if IR detected

  IF irLF = 1 OR irRF = 1 THEN
    DEBUG "IR interference detected!!!", CR
    FOR counter = 1 TO 7
      FREQOUT LedSpeaker, 50, 4000
      PAUSE 50
    NEXT
  ENDIF

LOOP                                   ' Repeat DO...LOOP

```

The modified Main Routine also necessitates a few smaller changes, like a `PIN` declaration for `LedSpeaker` as well as a `counter` variable for sending a series of rapid alarm beeps. The Initialization message in the next example program is also changed, as are the comments at the beginning of the program.

Example Program: IrInterferenceSniffer.bs2

`IrInterferenceSniffer.bs2` sounds the SumoBot's piezospeaker alarm whenever it receives infrared signals in the neighborhood of 38.5 kHz. This could be from another SumoBot, a handheld remote that controls a TV, a video recorder, or fluorescent lights with an interfering ballast.

- √ Make sure one of your SumoBots is running `TestFrontIrObjectDetectors.bs2`.
- √ Disconnect that first SumoBot from the serial cable and set it aside.
- √ Enter and save run `IrInterferenceSniffer.bs2`.
- √ Download it to the second SumoBot.
- √ Point the first SumoBot's IR LED headlights at the second SumoBot. The second SumoBot's alarm should sound indicating it has detected IR interference.
- √ Point the first SumoBot away from the second SumoBot, and the alarm should stop.
- √ Try walking under various fluorescent lights while pointing the second SumoBot (running `IrInterferenceSniffer.bs2`) at them. Does its alarm sound? If not, that's good. If yes, you'll want to keep your SumoBot Competition Ring well away from those lights, or turn them off.



Always test for and eliminate sources of IR interference near your SumoBot Competition Ring.

3

```
' -----[ Title ]-----
' Applied Robotics with the SumoBot - IrInterferenceSniffer.bs2
' This program tests for IR interference from other fluorescent lights,
' handheld remotes, video recorders and other SumoBot robots.

' {$STAMP BS2}                ' Target = BASIC Stamp 2
' {$PBASIC 2.5}              ' Language = PBASIC 2.5

' -----[ I/O Definitions ]-----

IrLedLF      PIN    4          ' Left IR LED connected to P4
IrSenseLF    PIN    11        ' Left IR detector to P11

IrLedRF      PIN    15        ' Right IR LED connected to P15
IrSenseRF    PIN    14        ' Right IR detector to P14

LedSpeaker   PIN    5          ' LED/speaker connected to P5

' -----[ Variables ]-----

irLF         VAR    Bit       ' State of Left Front IR
irRF         VAR    Bit       ' State of Right Front IR

counter      VAR    Byte      ' Loop counting variable

' -----[ Initialization ]-----

DEBUG CLS, "Checking for IR interference...", CR, CR

' -----[ Main Routine ]-----

DO                                                    ' DO...LOOP repeats indefinitely

  irLF = ~IrSenseLF                                  ' Save IR receiver output
  irRF = ~IrSenseRF

  IF irLF = 1 OR irRF = 1 THEN
    DEBUG "IR interference detected!!!", CR
    FOR counter = 1 TO 7
      FREQOUT LedSpeaker, 50, 4000
      PAUSE 50
    NEXT
  ENDIF

LOOP
```

Testing for Electrical Continuity

The leads on the IR LEDs and receivers tend to be thinner than jumper wires and other component leads. The X8 and X9 sockets on some SumoBot boards may also have sockets with slightly larger holes than the ones in the breadboard. A resulting loose fit could be a problem for some IR LEDs and detectors. During a match, vibration can cause brief electrical continuity interruptions between the IR component pins and the header sockets. This in turn can result in the SumoBot losing sight of its opponent, or maybe never even catching a glimpse.



Electrical Continuity is when there's a continuous pathway through which current can flow. If two conductive metals are firmly pressed against each other, it provides electrical continuity. If the pieces of metal are separated briefly, current can no longer flow, and electrical continuity is interrupted.

Sometimes skin oils or surface oxidation on the metal can prevent the actual conductive parts of the metal from making contact. The act of inserting a lead into a breadboard socket typically abrades the surfaces enough to establish electrical continuity.

Continuity Tests

- √ Remove one of the IR components from either the X8 or X9 header, and make a note of how much force you used. Did it slide right out, or did the socket kind of gently grip the components leads and resist the component's removal?

Especially if the component slid right out, the leads will lose contact (electrical continuity) during the jostling and vibration of a sumo match.

- √ If you are unsure if the socket gripped the leads firmly enough, compare it to removing the same component from the breadboard sockets.

If it's way easier to remove the component from the X8/X9 header than it is to remove it from the breadboard, it's also a good indicator that there will continuity problems during a match.

- √ Repeat for each component in the X8/X9 headers.

Ensuring Continuity

The SumoBot Robot Competition Kit may have extra components that are not used in the activities in this book, such as 10 μ F capacitors. The leads on these spare capacitors or

other parts can be clipped into small segments and inserted into very loose-fitting X8 and X9 sockets along with the component leads. Figure 3-4 shows examples.



If the IR component leads already have a snug fit in the X8/X9 sockets, do not follow these steps. Instead, move on to testing and tuning effective range.

3

- √ Clip one 5/16 inch (or 8 mm) segment of lead off a capacitor or other spare component for each excessively loose socket in the X8 and X9 headers.
- √ Make sure the IR component is properly inserted in the socket.
- √ Using a needle-nose pliers, insert the segment of capacitor lead into the socket along with the component lead. It may be a pretty tight fit, but that will give you some collision insurance during a match.

Figure 3-4 Clip Leads from Spare Components and Insert them into Loose Header Sockets

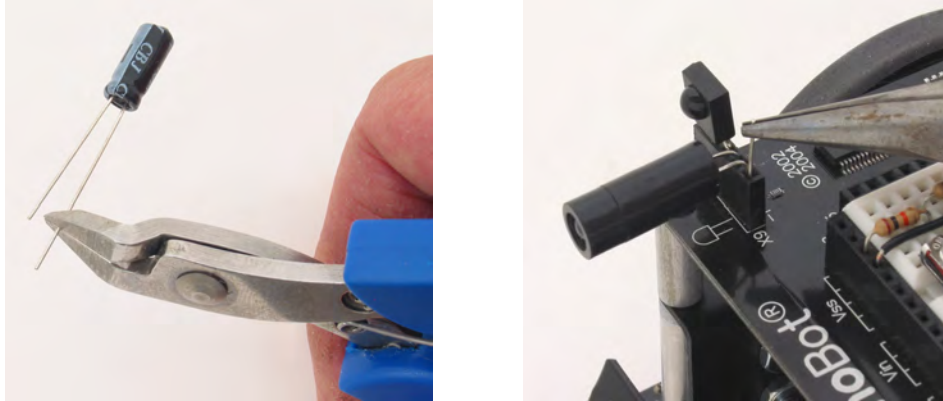

Testing and Tuning the Effective Range

In Figure 3-5's left scenario, the SumoBot sees its opponent, and will likely win the round. On the right, the same SumoBot is perusing an object outside the ring. Meanwhile, its opponent isn't having any problems with objects outside the ring, and will likely win the round.

Figure 3-5 Opponent vs. Distraction

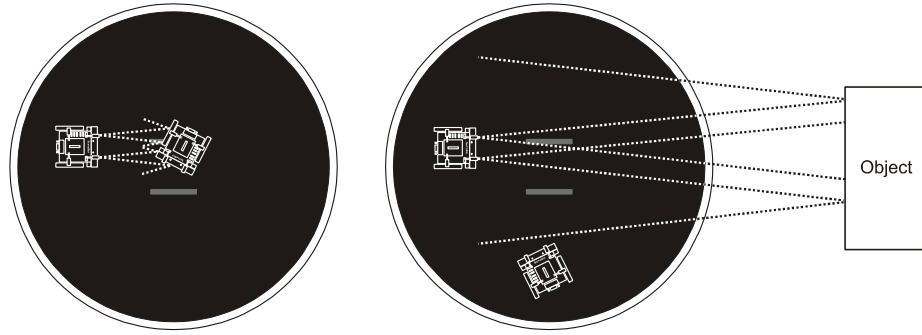

If your SumoBot has a tendency to get distracted by nearby objects, there are ways to make it more nearsighted. The sensitivity of the IR receivers can be adjusted by changing either the resistance in series with the IR LED or the `FREQOUT` command's frequency. A larger series resistor would make the IR LED headlights dimmer, and different frequencies would make the IR receivers less sensitive to reflected infrared.

However, changing the resistance in series with the IR LEDs isn't really a good option because the SumoBot board has 220 Ω IR LED series resistors built-in. So, we'll take a closer look at changing frequencies to make the IR object detectors more near/farsighted.

The way to test the relationship between near/farsightedness and IR LED frequency is to write a program that displays the detection results at a number of different frequencies. Then, test with objects outside the ring at different distances. Finally, test with an opponent SumoBot inside the ring at different distances. In some cases, the goal will be to find a frequency for each IR object detector that will be most likely to see its opponent and least likely to see objects outside the competition ring. This might also be the goal if the most sensitive IR frequency causes the IR object detectors to see the reflection of the floor outside the ring. On the other hand, if onlookers stay a meter or more outside the ring, and the reflection of the floor around the ring doesn't interfere, use the most sensitive frequency. It will give your SumoBot the best chances of detecting its opponent.

Figure 3-6 shows two examples of the Debug Terminal output from the next example program. The program makes the IR LED send frequencies ranging from 36 to 42 kHz,

The next example program is another modified version of TestIrFrontObjectDetectors.bs2. The IrFreq constant in the FREQOUT command's Freq1 argument is replaced with a word variable named frequency. This variable is swept from 36000 to 42000 in steps of 500 by a FOR...NEXT loop. It's a quick and easy way to perform a frequency sweep with the IR LEDs and capture the IR receivers' frequency responses.

```
' ----[ Main Routine ]-----
FOR frequency = 36000 TO 42000 STEP 500

  FREQOUT IrLedLF, 1, frequency           ' Left IRLED shines IR light
  IrLF = ~IrSenseLF                       ' Save IR receiver output

  FREQOUT IrLedRF, 1, frequency           ' Repeat for right IRLED/receiver
  IrRF = ~IrSenseRF

  DEBUG CR, DEC frequency, CRSRX, 11      ' Display yes/no for detection
  IF IrLF = 1 THEN DEBUG "yes" ELSE DEBUG "no"
  DEBUG CRSRX, 19
  IF IrRF = 1 THEN DEBUG "yes" ELSE DEBUG "no"

  PAUSE 50                                ' Delay for slower PCs

NEXT
```

	<p>Frequency Sweep and Frequency Response</p> <p>Transmitting a sequence of frequencies is commonly referred to as "frequency sweep". The response of a sensor or circuit to a frequency sweep is called its "frequency response".</p>
---	---

Example Program: TestFrequencyResponse.bs2

This program should be used with a white wall at various distances from the front of the SumoBot to get an idea of which frequencies make it more nearsighted and which frequencies make it more farsighted. These tests should then be repeated with a SumoBot in the ring. The goal is to determine a frequency for each detector that is most likely to detect the SumoBot opponent and least likely to detect a nearby onlooker.

- √ Enter, save, and run TestFrequencyResponse.bs2, and leave the SumoBot connected to the serial cable.
- √ Face the SumoBot at a white wall 1 m away.
- √ Press and release the Reset button.

- ✓ If zero "yes" readings appear, move the SumoBot 5 cm closer to the wall. If several "yes" readings appear, move the SumoBot 5 cm farther from the wall.
- ✓ Press and release the Reset button to refresh the Debug Terminal.
- ✓ Repeat until you find the distance threshold between no object detections and a few object detections at the most sensitive frequencies.
- ✓ Move the SumoBot closer in 5 cm increments, testing the frequency response between each move.
- ✓ Take notes and make an order of which frequencies can be used for closer and farther objects.
- ✓ Repeat this experiment with a SumoBot opponent across the ring.
- ✓ Keep moving the SumoBot closer in 5 cm increments, and track which frequencies detect it at which distances.



Selecting a frequency to use will depend on the location of the competition ring. If onlookers stay more than 1 m away from the outside of the ring and IR detectors aren't seeing the floor outside the ring, choose the most sensitive frequency. If onlookers are likely to be only 0.5 m outside the ring, or the object detectors see the floor's reflection, choose a compromise frequency that will be less likely to detect the floor or onlookers, but still pretty likely to detect its opponent.

You may also want to consider adding extra distance sensors, such as the Parallax Ping))) Ultrasonic Sensor. You can use its distance measurement capabilities to help your SumoBot decide whether it's viewing an onlooker or its opponent.

```
' -----[ Title ]-----
' Applied Robotics with the SumoBot - TestFrequencyResponse.bs2
' This program can be used with objects at varying distances to determine
' which frequencies make the SumoBot more nearsighted or farsighted.

' {$STAMP BS2}           ' Target = BASIC Stamp 2
' {$PBASIC 2.5}         ' Language = PBASIC 2.5

' -----[ I/O Definitions ]-----

IrLedLF      PIN      4           ' Left IR LED connected to P4
IrSenseLF    PIN      11          ' Left IR detector to P11

IrLedRF      PIN      15          ' Right IR LED connected to P15
IrSenseRF    PIN      14          ' Right IR detector to P14

' -----[ Variables ]-----

irLF         VAR      Bit         ' State of Left Front IR
irRF         VAR      Bit         ' State of Right Front IR
frequency    VAR      Word        ' Stores Frequencies
```

```

' -----[ Initialization ]-----
DEBUG CLS, "FRONT IR DETECTORS", CR,           ' Display heading
      "Frequency Left  Right", CR,
      "-----", CR

' -----[ Main Routine ]-----

FOR frequency = 36000 TO 42000 STEP 500

  FREQOUT IrLedLF, 1, frequency               ' Left IRLED shines IR light
  irLF = ~IrSenseLF                           ' Save IR receiver output

  FREQOUT IrLedRF, 1, frequency               ' Repeat for right IRLED/receiver
  irRF = ~IrSenseRF

  DEBUG CR, DEC frequency, CRSRX, 11         ' Display yes/no for detection
  IF irLF = 1 THEN DEBUG "yes" ELSE DEBUG "no"
  DEBUG CRSRX, 19
  IF irRF = 1 THEN DEBUG "yes" ELSE DEBUG "no"

  PAUSE 50                                    ' Delay for slower PCs

NEXT

```

Your Turn - Frequency Constants

Sometimes it is useful to “comment-out” a line of code in your program by placing an apostrophe to the left of it, effectively removing it from your executable code without removing it from your program. It's a good idea to keep some commented-out **IrFreq** constants along with the one you use regularly, as in the example below. That way, you can comment and uncomment various constants depending on what environment you are testing in. For example, when prototyping maneuvers, it's better to make your SumoBot nearsighted so that it only detects an object when you place your hand close to the sensor you want to detect an object. Medium range might work better for a competition ring in tight quarters, and maximum range might work better for a competition ring in a spacious area.

```

' -----[ Constants ]-----
IrFreq      CON      39500                    ' Maximum range
' IrFreq    CON      38500                    ' Medium range
' IrFreq    CON      41500                    ' Close range

```

- ✓ Modify TestIrFrontObjecDetectors.bs2 so that it has 3 or 4 useful versions of the `IrFreq CON` directive.

ACTIVITY #2: A CLOSER LOOK AT THE QTI LINE SENSORS

The SumoBot shown in Figure 3-7 has its QTI line sensors mounted under left and right sides of the plow. The QTIs are designed to detect the white tawara line, which is the border of the competition ring. This activity reviews the testing procedure for the QTI line sensors and takes a closer look at how they work.

Figure 3-7 QTI Line Sensor's on the SumoBot

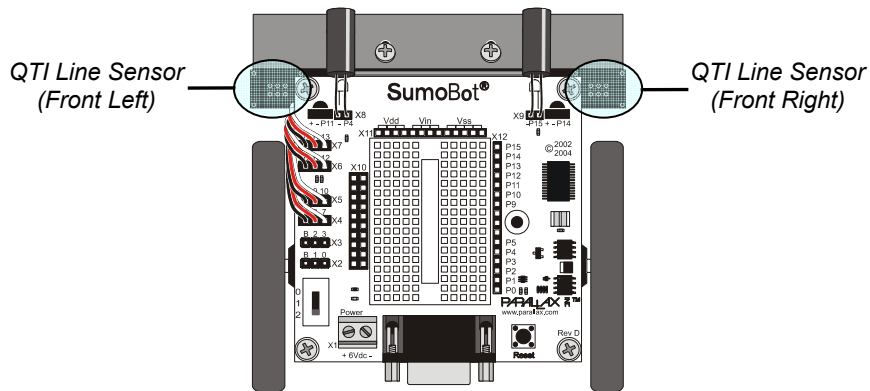

Testing the QTI Line Sensors

Figure 3-8 shows schematics of your SumoBot's two front QTI line sensors. Like the IR object detectors, the QTIs are connected to headers on your SumoBot. When you plug the cable into the QTI, the white wire should line up with the W on the QTI. Likewise, the red wire should line up with the R, and black with B. When plugging the other end of the cable into the header on the SumoBot board, make sure to line up the black wire with the pin labeled B. On the SumoBot PCB, the X5 header connects the pin labeled 10 to BASIC Stamp I/O pin P10. The PCB also connects the pin labeled 9 to I/O pin P9, and the pin labeled B to Vss. Header X4 makes similar connections, but with different I/O pin connections.

Figure 3-8 Front Left and Right QTI Schematics

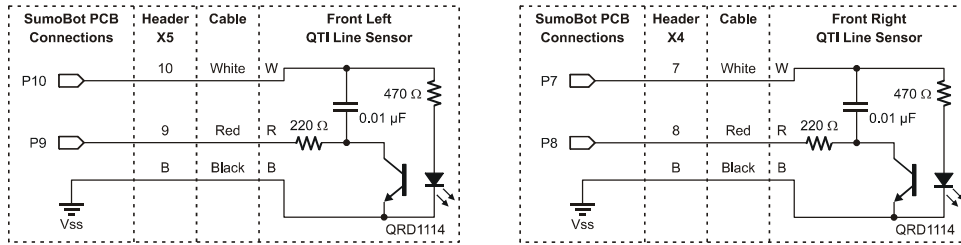

Each QTI has four components mounted on its PCB, a 220 Ω resistor, a 470 Ω resistor, a 0.01 μF capacitor, and a QRD1114 reflective object sensor. The way these parts are connected to the QTI's 3-pin header make it so that you can turn its power on or off by sending either a high or low signal to its W pin. The actual sensor measurements are taken through its R pin. For example, to turn the left QTI sensor on, send a high signal to P10. The left QTI is controlled and monitored through P9. The SumoBot's BASIC Stamp must set P9 high, waits 1 ms, then uses the `RCTIME` command to measure the time it takes for the voltage to drop to 1.4 V. If this time is small, the QTI senses a white surface. If this time is long, the QTI senses a black surface.

The QRD1114 contains two components. The device inside it that controls how long the voltage takes to drop from around 5 V to 1.4 V is called an infrared transistor. The schematic symbol for the IR transistor is shown in Figure 3-9. While an LED is like a 1 way current valve, a transistor is more like a variable current valve. It's analogous to a faucet. The more you turn the handle, the more water comes out. With an infrared transistor, the more infrared light that strikes the base (B) surface, the more current (I) the transistor allows to pass through its collector (C) and emitter (E).

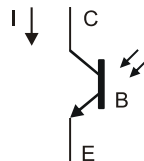

Figure 3-9 Infrared Transistor

The QRD1114 has an IRLED in it that shines IR light on the surface it's facing. Unlike the IR object detectors we just finished testing, this device does not need to flash the IR on/off at 38.5 kHz. That's because the QTI is designed to be held close enough to its target surface that IR from the window and the lamps in the room won't be as likely to interfere.

Figure 3-10 shows a simplified version of the QTI circuit with the power already turned on. The IR LED shines infrared on the nearby surface, which reflects this light, and it bounces back onto the base of the IR transistor. A white surface will reflect most of the IR while a black surface will absorb it. When more IR is reflected and strikes the base of the IR transistor, it lets more current through from the capacitor to Vss. When less IR is reflected, the IR transistor lets less current through from the capacitor to Vss.

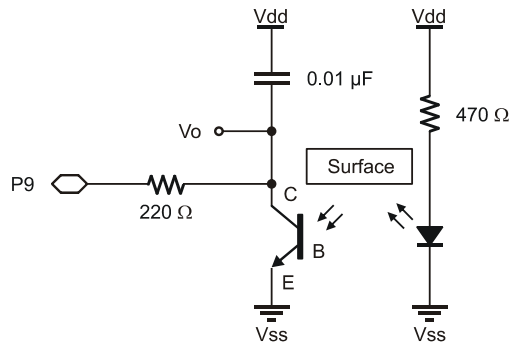

Figure 3-10
Simplified Version of
the QTI Circuit

By setting I/O pin P9 high for a while (1 ms), the voltage V_0 at the lower plate of the capacitor approaches 5 V. When P9 is set to an input, V_0 will start to decay because P9 is no longer forcing it to 5 V. The time it takes the voltage to decay to 1.4 V is controlled by the IR transistor. Here's how:

- More IR at the transistor's base, more current through the transistor.
- More current through the transistor, less decay time.
- Less IR at the transistor's base, less current through the transistor.
- Less current through the transistor, more decay time.

The `RCTIME` command measures the time it takes for the voltage to decay to around 1.4 V and stores it in a variable. Here is a code snippet that sets P9 high, pauses for 1 ms, then

uses **RCTIME** to measure and store the time it took for V_0 to decay to 1.4 V in a variable named **temp**:

```
HIGH 9
PAUSE 1
RCTIME 9, 1, temp
```

Remember that P10 has to be set high to turn on the QTI, and low to turn it back off again when the measurement is done. With the use of **PIN** directives to give each I/O pin a name, the code should look about like this:

```
qtiPwrLeft    PIN    10           ' Left QTI on/off pin
qtiSigLeft    PIN    9           ' Left QTI signal pin

qtiLeft       VAR    Word        ' Stores left QTI time

HIGH qtiPwrLeft           ' Turn left QTI on
HIGH qtiSigLeft           ' Discharge capacitor
PAUSE 1
RCTIME qtiSigLeft, 1, temp ' Measure charge time
LOW qtiPwrLeft            ' Turn left QTI off

DEBUG CRSRX, 0, DEC5 qtiLeft ' Display time measurement
```

The rate at which the voltage decays is shown in Figure 3-11. When the QTI is over the white tawara line that surrounds the sumo ring surface, lots of reflected IR makes it to the IR transistor's base. In this situation, the IR transistor will conduct more current, and V_0 will drop very quickly. A typical **RCTIME** value for this is 85, though it could range anywhere between 15 and 350 depending on the surface and the ambient light in the room. When the QTI is placed over the black sumo ring, the value might be 1500. That's because the black surface absorbs infrared, and not nearly as much makes it to the base of the IR transistor. With less IR striking its base, the transistor conducts less current, and V_0 decays much more slowly.

Figure 3-11 QTI RC-Decay for Different Surfaces

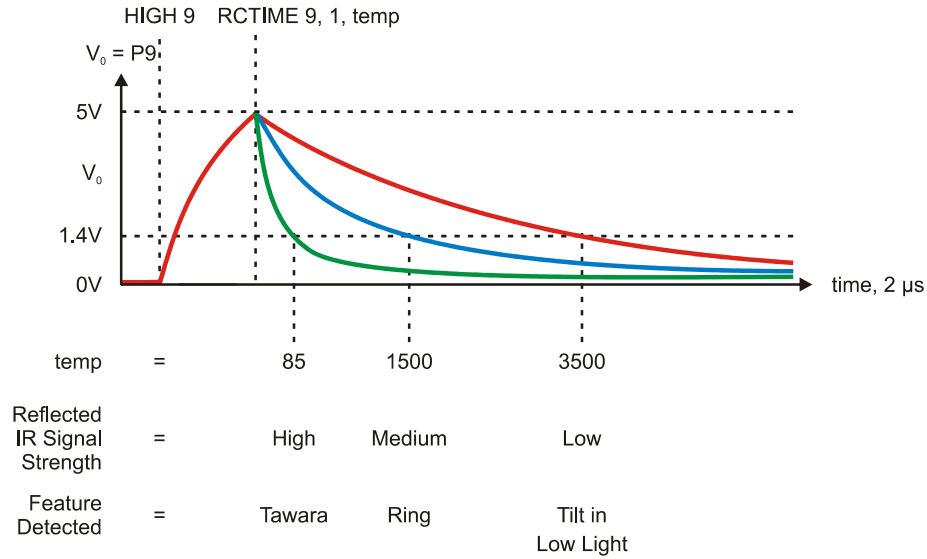

If there is no surface to reflect IR from the QTI's IR LED, the only source of infrared for the IR transistor's base is the ambient light in the room. That might be a lot of infrared if sunlight is streaming through the windows, or a little if the blinds are closed and only a few fluorescent lights are on. That's the case with the 3500 `RCTIME` measurement. Keep in mind, your values will also vary with the type of surfaces you are using.

Figure 3-12 shows an example of the SumoBot with one QTI over the white tawara line, and the other QTI over the black sumo ring surface. It also shows an example of what the Debug Terminal might display under these conditions. The left QTI only reads 66, a strong indication that the QTI is over a white line. The right sensor reads 1554, which is typical for a dark surface. These values will vary from one room and sumo ring to the next, and in an upcoming activity, we'll take a close look at self calibration so that your SumoBot can automatically adjust to its environment.

Avoiding Interference to the QTI's –The QTI sensor has a built-in daylight filter that is adequate for indirect sunlight indoors. However, you should still avoid placing your sumo ring in direct or bright indirect sunlight. If you find that your sumo-ring's surface is too reflective in direct sunlight, causing false QTI readings, move your ring to an indoor shaded location.

Figure 3-12 White Tawara vs. Black Sumo Ring Surface

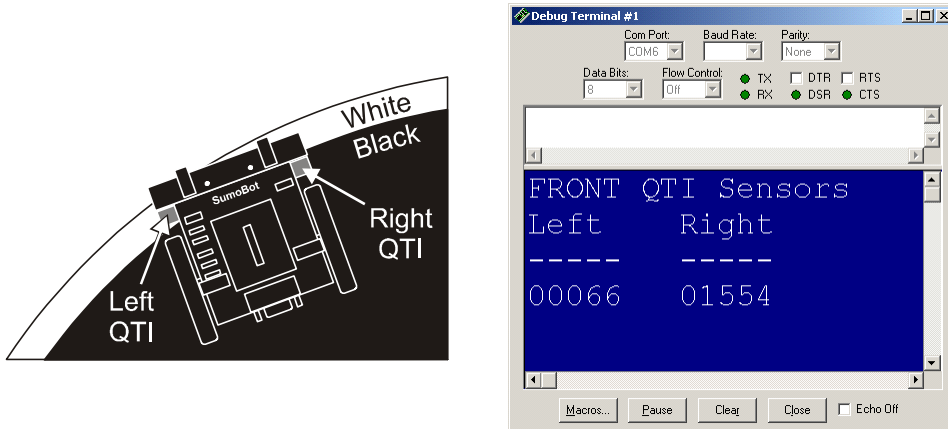

Example Program - TestFrontQtiLineSensors.bs2



Keep well away from direct sunlight and other sources of bright light. Your SumoBot and SumoBot Robot Competition Ring poster should be well away from any sources of direct sunlight and other bright lights. Close nearby blinds if necessary, and make sure the light sources in your work area are either fluorescent or indirect incandescent.

- ✓ Enter, save, and run TestFrontQtiLineSensors.bs2.
- ✓ Test both QTI sensors light and dark surfaces.
- ✓ Test both QTI sensors on the Sumo Ring poster in the black area, the white tawara border, and the dark gray shikiri lines.
- ✓ Make notes of all the QTI measurements.
- ✓ Try it in a brightly lit room.
- ✓ Try it in a dimly lit room and compare the difference.
- ✓ Try a variety of black and white surfaces and consider what value you think would be best for your programs to decide whether a QTI is over a black or white surface.

```
' -----[ Title ]-----  
' Applied Robotics with the SumoBot - TestFrontQtiLineSensors.bs2  
' Tests values returned by QTI lines sensors mounted on  
' the front of the SumoBot.
```



```

' {$STAMP BS2}                                ' Target = BASIC Stamp 2
' {$PBASIC 2.5}                                ' Language = PBASIC 2.5

' -----[ I/O Definitions ]-----
qtiPwrLeft    PIN    10                        ' Left QTI on/off pin
qtiSigLeft    PIN    9                        ' Left QTI signal pin

qtiPwrRight   PIN    7                        ' Right QTI on/off pin
qtiSigRight   PIN    8                        ' Right QTI signal pin

' -----[ Variables ]-----
qtiLeft       VAR    Word                    ' Stores left QTI time
qtiRight      VAR    Word                    ' Stores right QTI time

' -----[ Initialization ]-----
DEBUG CLS, "FRONT QTI Sensors", CR,          ' Display heading
        "Left   Right", CR,
        "-----   -----", CR

' -----[ Main Routine ]-----
DO                                           ' DO...LOOP repeats indefinitely

  GOSUB Read_Line_Sensors                   ' Update qtiLeft & qtiRight

  DEBUG CRSRX, 0, DEC5 qtiLeft              ' Display time measurement
  DEBUG CRSRX, 8, DEC5 qtiRight            ' Display time measurement

  PAUSE 100                                 ' Delay for slower PCs
LOOP

' -----[ Subroutines ]-----
Read_Line_Sensors:

  HIGH qtiPwrLeft                          ' Turn left QTI on
  HIGH qtiSigLeft                          ' Discharge capacitor
  PAUSE 1
  RCTIME qtiSigLeft, 1, qtiLeft            ' Measure charge time
  LOW qtiPwrLeft                          ' Turn left QTI off

  HIGH qtiPwrRight                         ' Turn right QTI on
  HIGH qtiSigRight                        ' Discharge capacitor
  PAUSE 1
  RCTIME qtiSigRight, 1, qtiRight         ' Measure charge time

RETURN

```

Your Turn - Detecting Tilt

What if the QTIs were to give you a unique signature when the SumoBot is tilted backward?

- √ Try tilting the SumoBot while it's sitting on the sumo ring.
- √ Are the readings different from black and white?
- √ How does the light level in the room effect tilt measurements?



Strategy tip

While it seems like this might be a great way to detect whether your SumoBot is at a disadvantage, it tends not to work in practice. Whether the SumoBot's plow is under or over its opponent's, both SumoBots may tip upward for a moment as they push against each other. Therefore, detecting a tilt does not necessarily indicate that your SumoBot is winning or losing, so these measurements would not necessarily be helpful in deciding what type of maneuver to do next. While QTI tilt is probably a blind alley, similar experiments may lead to more useful sensor data and new strategies.

ACTIVITY #3: SELF CALIBRATING QTI SENSORS

As mentioned earlier, different lighting conditions and different competition rings will cause the QTIs to give different measurements. If you selected a value to discern between the black ring and the white tawara line based on your own practice ring, you might be in for a surprise when you move your ring to a different location or use a ring made of different materials. Reason being, the value you chose for your practice ring might not work with the new conditions. When this happens, your SumoBot will drive right out of the ring, maybe before it's even had a chance to engage with its opponent.

The solution to this problem was first introduced in the SumoBot text - a QTI self-calibration routine. In this activity, you will take a closer look at how this kind of self-calibration routine works.

QTI Self Calibration Code

Making the QTIs self calibrating isn't difficult if you start with the example program from this chapter's Activity #2 - TestFrontQtiLineSensors.bs2. The first step is to add a word variable to store a threshold value.

```
qtiThreshold    VAR    Word
```

Since the SumoBot will have to start off in the middle of the ring, the only piece of information it will have is the QTI measurements for the black surface. The program

should measure the QTI readings for the black surface and use them as a basis for setting a threshold value to decide whether the QTIs are "seeing" black or white. As you may have noticed from Activity #2, white QTI measurements are very small in comparison. Your program can safely set the threshold at 1/4 of the average of the two QTI sensors' measurements of black. It takes three steps: (1) call the `Read_Line_Sensors` subroutine to update the values of `qtiLeft` and `qtiRight`. (2) take the average of the two readings. (3) divide this average by 4. Here is an example:

```
GOSUB Read_Line_Sensors
qtiThreshold = (qtiLeft + qtiRight) / 2
qtiThreshold = qtiThreshold / 4
```



You can set higher or lower thresholds. For example, if you divide `qtiThreshold` by 3 instead of 4, the threshold will be higher. If you divide `qtiThreshold` by 5 or 6, the threshold will be lower. A lower threshold value makes the SumoBot less likely to mistake a crease in the SumoBot Robot Competition Ring for a white tawara line. It also helps somewhat in brightly lit rooms. In contrast, a higher threshold value may be better for rings where there is less difference in IR reflectivity between black and white.

You can also save a line of code. These two lines of code:

```
qtiThreshold = (qtiLeft + qtiRight) / 2
qtiThreshold = qtiThreshold / 4
```

are equivalent to this one line of code:

```
qtiThreshold = (qtiLeft + qtiRight) / 8
```

To discern whether the QTI is looking at black or white, use `IF . . . THEN` statements:

```
IF qtiLeft < qtiThreshold THEN
  DEBUG "White"
ELSE
  DEBUG "Black"
ENDIF
```

The next example program uses these code blocks to tell you whether each QTI is looking at black or white. Figure 3-13 shows an example of how this program can be used to test the calibration routine and make sure it's working right.

Figure 3-13 White Tawara vs. Black Sumo Ring Surface

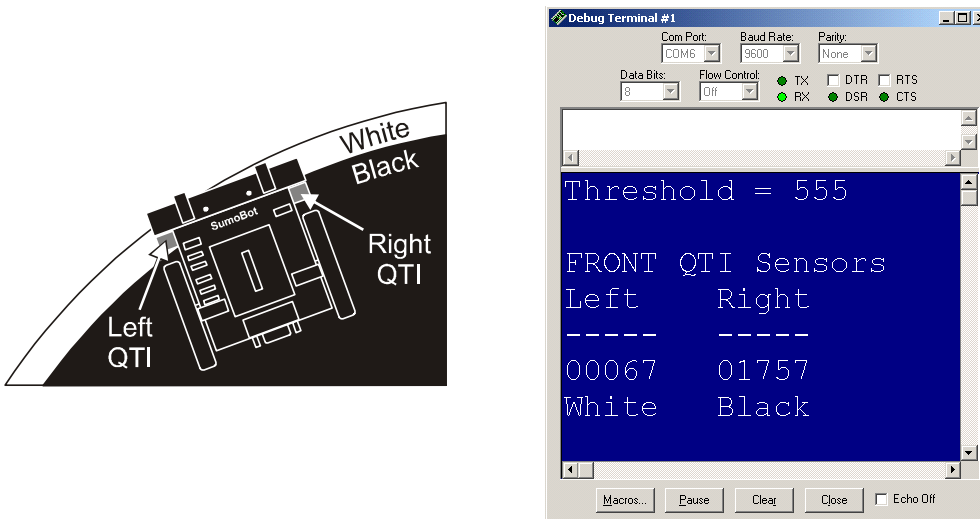

Example Program: QtiSelfCalibrate.bs2

- ✓ Place the SumoBot on the black part of your practice ring.

Lighting Reminder

Your SumoBot and SumoBot Robot Competition Ring poster should be well away from any sources of direct sunlight and other bright lights. Close nearby blinds if necessary, and make sure the light sources in your work area are either fluorescent or indirect incandescent.

- ✓ Enter, save and run QtiSelfCalibrate.bs2.
- ✓ Position your SumoBot so that the left QTI is over the white tawara line as shown in Figure 3-13, and verify that the display reports white for the left side.
- ✓ Repeat for the right QTI, then for both QTIs.

```
' -----[ Title ]-----  
' Applied Robotics with the SumoBot - QtiSelfCalibrate.bs2  
' This program sets a threshold between black and white, and then displays  
' whether the QTI sees black or white.  
  
' Important: You must start with the QTIs seeing black.
```

```

' {$STAMP BS2}                                ' Target = BASIC Stamp 2
' {$PBASIC 2.5}                                ' Language = PBASIC 2.5

' -----[ I/O Definitions ]-----
qtiPwrLeft    PIN    10                        ' Left QTI on/off pin
qtiSigLeft    PIN    9                        ' Left QTI signal pin

qtiPwrRight   PIN    7                        ' Right QTI on/off pin
qtiSigRight   PIN    8                        ' Right QTI signal pin

' -----[ Variables ]-----
qtiLeft       VAR    Word                    ' Stores left QTI time
qtiRight      VAR    Word                    ' Stores right QTI time
qtiThreshold  VAR    Word                    ' Stores black/white threshold

' -----[ Initialization ]-----
GOSUB Read_Line_Sensors                      ' Get reflection values
qtiThreshold = (qtiLeft + qtiRight) / 2      ' Calculate average
qtiThreshold = qtiThreshold / 4              ' Take 1/4 average

DEBUG CLS, "Threshold = ",DEC qtiThreshold    ' Display threshold

DEBUG CR, CR, "FRONT QTI Sensors", CR,      ' Display column headings
      "Left   Right", CR,
      "-----  -----", CR

' -----[ Main Routine ]-----
DO                                            ' DO...LOOP repeats indefinitely

  GOSUB Read_Line_Sensors                    ' Get reflection values

  DEBUG CRSRXY, 0, 5,
        DEC5 qtiLeft, CRSRX, 8,             ' Display reflection values
        DEC5 qtiRight, CR

  IF qtiLeft < qtiThreshold THEN            ' Indicate what left QTI sees
    DEBUG "White"
  ELSE
    DEBUG "Black"
  ENDIF

  DEBUG CRSRX, 8

  IF qtiRight < qtiThreshold THEN           ' Indicate what right QTI sees
    DEBUG "White"
  ELSE
    DEBUG "Black"
  ENDIF

```

```

    DEBUG "Black"
    ENDIF

    PAUSE 100                                ' Delay for slower PCs

LOOP

' -----[ Subroutine - Read_Line_Sensors ]-----
Read_Line_Sensors:

    HIGH qtiPwrLeft                          ' Turn left QTI on
    HIGH qtiSigLeft                          ' Discharge capacitor
    PAUSE 1
    RCTIME qtiSigLeft, 1, qtiLeft            ' Measure charge time
    LOW qtiPwrLeft                           ' Turn left QTI off

    HIGH qtiPwrRight                         ' Turn right QTI on
    HIGH qtiSigRight                         ' Discharge capacitor
    PAUSE 1
    RCTIME qtiSigRight, 1, qtiRight         ' Measure charge time

    RETURN

```

Your Turn - QTI Navigation Decisions

Incorporating navigation can be as simple as an **IF...THEN** statement that calls subroutines that perform preprogrammed maneuvers. Instead of subroutine calls, the code block below uses **DEBUG** commands to display what action should be taken.

- √ Save QtiSelfCalibrate.bs2 as QtiSelfCalibrateYourTurn.bs2
- √ Remove the two **IF...THEN...ENDIF** code blocks, and replace them with this:

```

' Indicate maneuver that should be taken based on QTI readings

    DEBUG CR, "Maneuver",
           CR, "-----", CR

    IF qtiLeft < qtiThreshold AND qtiRight < qtiThreshold THEN
        DEBUG "Avoid tawara - both"
    ELSEIF qtiLeft < qtiThreshold THEN
        DEBUG "Avoid tawara - left"
    ELSEIF qtiRight < qtiThreshold THEN
        DEBUG "Avoid tawara - right"
    ELSE
        DEBUG "search"
    ENDIF
    DEBUG CLREOL

```

- √ Save and then run the modified program, starting with both QTIs over a black portion of the practice ring.
- √ Repeat your tests with the tawara line, and verify that the SumoBot is making the correct navigation decisions.

ACTIVITY #4: READING THE QTI SENSORS MORE QUICKLY

How much time does it take to read QTIs? It depends a lot on the surface and the lighting conditions in the room. If both QTIs are on the black surfaces in the examples from Activities #2 and #3, they tend to be in the 1000 to 4000 range. The time measurement the **RCTIME** command stores in a variable are in terms of 2 μs units. So, an **RCTIME** measurement of 2000 equates to 4 ms:

$$\begin{aligned} \text{time(ms)} &= \text{RCTIME measurement} \times 2 \mu\text{s} \times \frac{1\text{ms}}{1000 \mu\text{s}} \\ &= 2000 \times 2 \mu\text{s} \times \frac{1\text{ms}}{1000 \mu\text{s}} \\ &= 4000 \mu\text{s} \times \frac{1\text{ms}}{1000 \mu\text{s}} \\ &= 4\text{ms} \end{aligned}$$

Since there are two QTIs, that's 8 ms between servo pulses. What if the material is more absorbent of infrared, and the room is dark? Maybe both QTIs will return a measurement of 3600, which equates to 7.2 ms per QTI, and 14.4 ms for the pair of them. There's probably 2 ms of processing time to execute all the commands in the **Read_Line_Sensors** subroutine, and another 2 ms worth of **PAUSE** commands to set up for the **RCTIME** measurements. That adds up to 18.4 ms. By the measurements in Chapter 1, Activity #2, there's probably still enough time to check the IR detectors without slowing down the servos.

What if you want to add a pair of QTIs to check the back of the SumoBot? That's twice the time, or 36.4 ms. That will slow the servos down, and there still hasn't been any time to check the IR detectors. You might be able to fix the problem by checking some of the sensors between one set of servo pulses, and another set of sensors between the next. It will reduce the time between servo pulses, but at the same time, it will increase the risk that your SumoBot won't see something in time, like its opponent or the white tawara line.

With some creative programming, you can actually check as many QTIs as you want, and it will only a fraction of the time that it takes to check just one QTI with the **RCTIME** command when it's detecting black. This activity will show you how.

The Pulse-Decay Trick

Figure 3-14 is a repeat of Figure 3-10, a schematic for what's happening inside the QTIs after Vdd has been applied to its on/off input, P10.

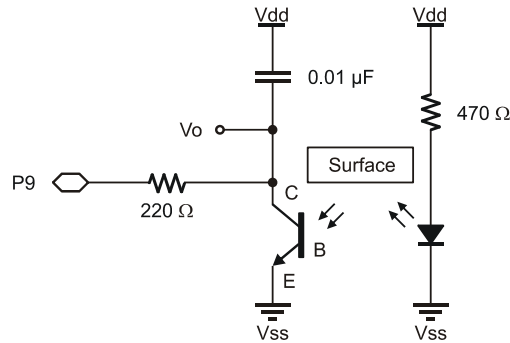

Figure 3-14
Simplified Version of
the QTI circuit

Below is a routine that calibrates only the left QTI. After turning the device on by setting P10 high, P9 is also set high, which pushes the value of V_0 toward 5 V. After a 1 ms pause, the **RCTIME** command measures the time it takes for V_0 to decay to 1.4 V. The amount of time it takes gets stored in the **time** variable. The **threshold** variable is set equal to 1/4 the value of the **time** variable.

```
HIGH 10
HIGH 9
PAUSE 1
RCTIME 9, 1, time
threshold = time / 4
```

The program could next use the **RCTIME** command and compare the decay time to the threshold time. If the decay time is greater than the threshold time, the program can assume the QTI is detecting black. If the decay time is less than the threshold time, the program can assume the QTI is detecting white.

The code block below takes less time than an **RCTIME** command would over a black surface. It starts like it's going to take an **RCTIME** measurement, by setting P9 high and waiting 1 ms for the V_0 to approach 5 V. Instead of taking an **RCTIME** measurement, the code block changes P9 from output to input. That's the same thing the **RCTIME** command does internally, and it's what causes the voltage to start to decay. Instead of waiting for the voltage to decay all the way to 1.4 V like the **RCTIME** command would, this code block sends a **PULSOUT** command to an I/O pin whose circuit will not be affected by it (the pushbutton).

```
HIGH 9
PAUSE 1
INPUT 9
PULSOUT 6, threshold
qtiStateLeft = IN9
```

What about the pushbutton?



True, P6 is connected to the pushbutton, but while the pushbutton is not being monitored, **PULSOUT** commands can be sent to it. It is safe to be used as an output because of the 470 Ω current-limiting resistor between the I/O pin and the pushbutton terminal. Regardless of whether the pushbutton is pressed or not pressed, the I/O pin is protected. Before the pushbutton is checked, P6 will have to be set back to input with the command **INPUT 6**, or if you have used the **PIN** declaration for it in your program, **INPUT pbSense**.

Keep in mind that the *Duration* of this **PULSOUT** command is the **threshold** variable. Figure 3-15 shows what happens in terms of the signals. The instant the **PULSOUT** command finishes is the instant the threshold amount of time has passed. The code block takes a snapshot of **IN9** at that instant by copying the value it stores into a variable named **qtiStateLeft**. If the QTI sees white, V_0 will have decayed below 1.4 V, and **IN9** will store 0. If the QTI sees black, V_0 will not have decayed below 1.4 V, and **IN9** will store 1.

Figure 3-15 Pulse-Decay Trick Timing

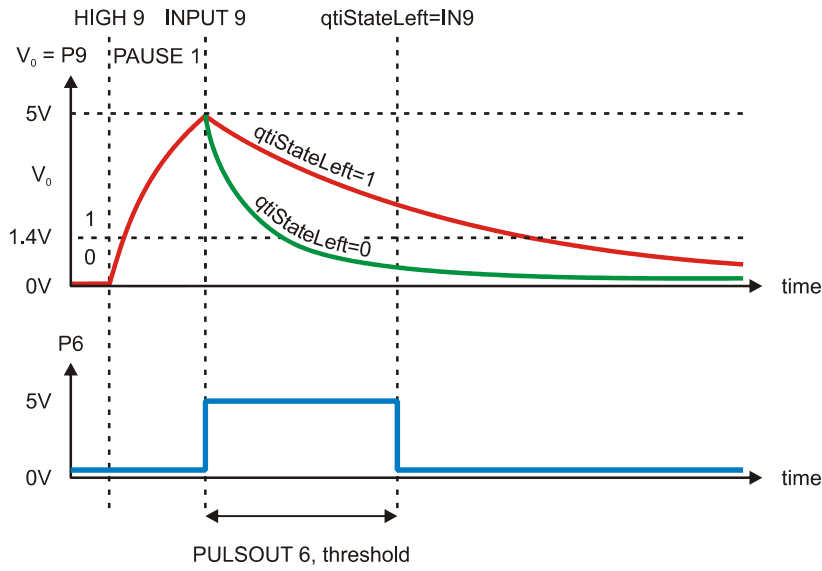

Accounting for Command Execution Times

Figure 3-15 shows the ideal situation, ignoring the amount of time it takes for the BASIC Stamp 2 to transition from one command to the next. Subtracting 220 from the `threshold` variable will make your `PULSOUT 6, threshold` command delay for the correct amount of time. Of course, if you subtract 220 from a value that's smaller than 220, your program will have a negative result, which won't be any good either. That's why it's best to have an `IF...THEN` statement check the value of `time` before subtracting 220



```
HIGH 10
HIGH 9
PAUSE 1
RCTIME 9, 1, time
threshold = time / 4
```

```
IF threshold > 220 THEN           ' Account for code overhead
  threshold = threshold - 220
ELSE
  threshold = 0
ENDIF
```

You can measure these times with the Parallax USB Oscilloscope. To learn more about the 'scope and the Understanding Signals student guide, see the #28119 product page at www.parallax.com.

Example Program: QtiPulseTrickLeft.bs2

The QtiPulseTrickLeft.bs2 program verifies that this technique works. Examine it carefully. Especially make sure you can match the commands that deal with P5 and P9 to the timing diagram in Figure 3-15.

- √ Make sure the left QTI is over the black surface in your sumo ring.
- √ Enter, save, and run QtiPulseTrickLeft.bs2.
- √ Verify that the Debug Terminal shows that the `qtiStateLeft` variable is 1 when the left QTI sees black and 0 when it sees white.

```
' Applied Robotics with the SumoBot - QtiPulseTrickLeft.bs2

' {$STAMP BS2}                ' Target device = BS2
' {$PBASIC 2.5}              ' Language = PBASIC 2.5

qtiStateLeft  VAR    Bit      ' Store left QTI state
time          VAR    Word     ' Store QTI decay time
threshold     VAR    Word     ' Store b/w threshold

' Calibrate QTIs

HIGH 10                ' Turn on left QTI
HIGH 9                 ' Discharge QTI capacitor
PAUSE 1               ' Wait for discharge
RCTIME 9, 1, time     ' Vo decay time as cap charges
threshold = time / 4  ' Use to set threshold

IF threshold > 220 THEN ' Account for code overhead
  threshold = threshold - 220
ELSE
  threshold = 0
ENDIF

' Main Routine

DO

  HIGH 9                ' Discharge QTI capacitor
  PAUSE 1               ' Wait for discharge
  INPUT 9               ' Start RC decay
  PULSOUT 6, threshold ' Wait until threshold time
  qtiStateLeft = IN9    ' Save state of P9

  DEBUG HOME, ? qtiStateLeft ' Display state of P9
  PAUSE 100            ' Delay for slower PCs

LOOP
```

Your Turn - Incorporating the Right QTI

Here's the interesting part, you can add another QTI measurement to the same block of code that performed the time measurement on the left QTI. The routine will take approximately the same amount of time, but you will be measuring two QTIs.

- √ Add a variable declaration for the state of the right QTI.

```
qtiStateLeft  VAR      Bit
```

- √ Add this code block right after the code that sets the threshold based on P9 measurements. It should be inserted just above the **IF threshold > 220 THEN** statement.

```
HIGH 7
HIGH 8
PAUSE 1
RCTIME 8, 1, time

threshold = (threshold + (time / 4)) / 2
```

- √ Add the commands with ' <---Add comments to the existing code in the Main Routine's **DO...LOOP**:

```
HIGH 9
HIGH 8           ' <--- Add
PAUSE 1
INPUT 9
INPUT 8         ' <--- Add
PULSOUT 5, threshold
qtiStateLeft = IN9
qtiStateRight = IN8       ' <--- Add

DEBUG HOME, ? qtiStateLeft
DEBUG ? qtiStateRight    ' <--- Add
PAUSE 100
```

- √ Save and run the program
- √ Test the program and verify that both QTI's now indicate white tawara line with 0 or black ring surface with 1.

Incorporating the Pulse-Decay Trick into Another Program

Here is how to incorporate the test code from `QtiPulseTrickLeft.bs2` into `TestFrontQtiLineSensors.bs2` from Activity #2. The first step is to declare a dummy `PIN` name for P6.

```
DummyPin      PIN      6
```

Also declare a couple of extra bit variables to store the states of `qtiSigLeft` (P9) and `qtiSigRight` (P8). Remember, they need a snapshot immediately after the `PULSOUT` command that passes the threshold amount of time:

```
qtiStateLeft  VAR      Bit
qtiStateRight VAR      Bit
```

Next, move the entire contents of the QTI calibration code block from the initialization routine into a single subroutine and name it `Calibrate_Qtis`:

```
Calibrate_Qtis:

HIGH qtiPwrLeft           ' Turn left QTI on
HIGH qtiSigLeft           ' Discharge capacitor
PAUSE 1
RCTIME qtiSigLeft, 1, qtiLeft ' Measure charge time
LOW qtiPwrLeft            ' Turn left QTI off

HIGH qtiPwrRight          ' Turn right QTI on
HIGH qtiSigRight          ' Discharge capacitor
PAUSE 1
RCTIME qtiSigRight, 1, qtiRight ' Measure charge time

qtiThreshold = (qtiLeft + qtiRight) / 2 ' Calculate average
qtiThreshold = qtiThreshold / 4        ' Take 1/4 average

IF threshold > 220 THEN ' For code overhead
  threshold = threshold - 220
ELSE
  threshold = 0
ENDIF

RETURN
```

After the `Calibrate_Qtis` subroutine is called, the program can use a modified version of the `Read_Line_Sensors` subroutine that uses the pulse-decay trick. Here it is, and it's essentially the same as the code block from the previous `Your Turn`.

```

Read_Line_Sensors:

    HIGH qtiPwrLeft           ' Turn on QTIs
    HIGH qtiPwrRight
    HIGH qtiSigLeft           ' Push signal voltages to 5 V
    HIGH qtiSigRight
    PAUSE 1                   ' Wait 1 ms for capacitors

    INPUT qtiSigLeft          ' Start the decays
    INPUT qtiSigRight
    PULSOUT DummyPin, qtiThreshold ' Wait for threshold time

    qtiStateLeft = qtiSigLeft ' Snapshot of QTI signal states
    qtiStateRight = qtiSigRight

    LOW qtiPwrLeft           ' Turn off QTIS
    LOW qtiPwrRight

    RETURN

```

The last step is to go through the Main Routine and change references to variables from `qtiLeft` and `qtiRight` to `qtiStateLeft` and `qtiStateRight`. The values also have to be compared to 0 or 1 instead of `threshold`. For example:

```
IF qtiLeft < qtiThreshold THEN
```

has to be changed to

```
IF qtiStateLeft = 0 THEN
```

Example Program: QtiPulseDecayTrick.bs2

- √ Start with your SumoBot parked on the black part of your practice sumo ring.
- √ Enter, save, and run QtiPulseDecayTrick.bs2.
- √ Verify that the Debug Terminal shows that the QTIs report 1 if they are over the black practice ring surface or 0 if they are over the white tawara line.

```

' -----[ Title ]-----
' Applied Robotics with the SumoBot - QtiPulseDecayTrick.bs2
' This program uses the Pulse-Decay trick to discern between black and white
' with QTI line sensors.

' Important: You must start with the QTIs seeing black.

' {$STAMP BS2}           ' Target = BASIC Stamp 2
' {$PBASIC 2.5}         ' Language = PBASIC 2.5

```



```

LOOP
' -----[ Subroutine - Calibrate_Qtis ]-----
Calibrate_Qtis:
HIGH qtiPwrLeft           ' Turn left QTI on
HIGH qtiSigLeft           ' Discharge capacitor
PAUSE 1
RCTIME qtiSigLeft, 1, qtiLeft ' Measure charge time
LOW qtiPwrLeft            ' Turn left QTI off

HIGH qtiPwrRight          ' Turn right QTI on
HIGH qtiSigRight          ' Discharge capacitor
PAUSE 1
RCTIME qtiSigRight, 1, qtiRight ' Measure charge time

GOSUB Read_Line_Sensors   ' Get reflection values
qtiThreshold = (qtiLeft + qtiRight) / 2 ' Calculate average
qtiThreshold = qtiThreshold / 4 ' Take 1/4 average

IF qtiThreshold > 220 THEN ' Account for code overhead
  qtiThreshold = qtiThreshold - 220
ELSE
  qtiThreshold = 0
ENDIF

RETURN

' -----[ Subroutine - Read_Line_Sensors ]-----
Read_Line_Sensors:
HIGH qtiPwrLeft           ' Turn on QTIs
HIGH qtiPwrRight          ' Push signal voltages to 5 V
HIGH qtiSigLeft           '
HIGH qtiSigRight          '
PAUSE 1                    ' Wait 1 ms for capacitors

INPUT qtiSigLeft          ' Start the decays
INPUT qtiSigRight         '
PULSOUT DummyPin, qtiThreshold ' Wait for threshold time

qtiStateLeft = qtiSigLeft ' Snapshot of QTI signal states
qtiStateRight = qtiSigRight

LOW qtiPwrLeft            ' Turn off QTIS
LOW qtiPwrRight           '

RETURN

```

Your Turn - Active High vs. Active Low

At present, the alert for the SumoBot encountering the white tawara line is when either `qtiStateLeft` or `qtiStateRight` store 0. You can use the invert bits operator (`~`) to change this so that the `qtiState` variables store 1 when they see they see white.

- √ Use the invert bits operator, the tilde `~`, to invert the states of the `qtiSig PIN` names before storing them in the `qtiState` variables. In other words, change:

```
qtiStateLeft = qtiSigLeft
qtiStateRight = qtiSigRight
```

to

```
qtiStateLeft = ~ qtiSigLeft
qtiStateRight = ~ qtiSigRight
```

- √ Update the **IF...THEN** statements that are checking for `qtiState` variables being equal to zero. They need to check for the `qtiState` variables being equal to 1.
- √ Save, run and test your modified program.

ACTIVITY #5: ADDING AND TESTING SENSORS AND INDICATORS

Figure 3-16 shows the SumoBot with IR object detectors added to the breadboard that will detect opponents on the side. The next activity adds and tests these sensors.

Figure 3-16 Sensors and Indicators Built on the Breadboard

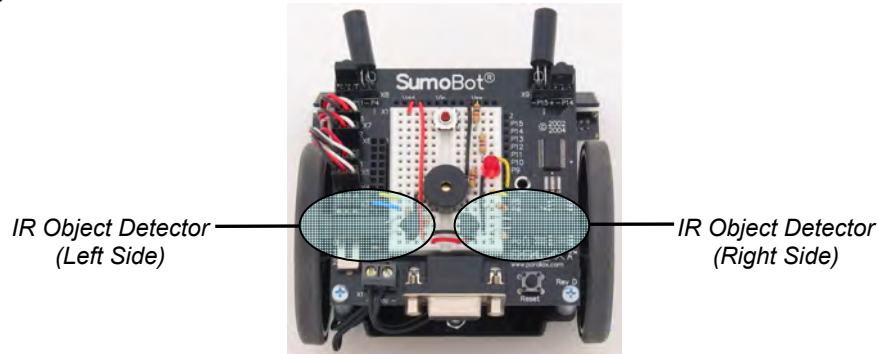

Building and Testing the Side-Mounted IR Object Detector Circuits

Figure 3-17 shows schematics of the side mounted IR LED and IR receiver pairs that comprise the left and right side object detectors. These detectors have the essentially the same components as the ones connected to the X8/X9 headers. A 470 Ω resistor has been added to the IR receiver outputs to prevent problems that can occur if you accidentally try to send a signal to P0 or P1. P0 and P1 should always be inputs, receiving signals from the IR receiver output pins.

Parts Required

- (2) IR LEDs
- (2) IR LED standoffs
- (2) IR LED light shields
- (2) IR detectors
- (2) Resistors - 470 Ω (yellow-violet-brown)
- (2) Resistors - 220 Ω (red-red-brown)
- (7) Jumper wires

- √ Build the circuit shown in Figure 3-17 with the help of the wiring diagram in Figure 3-18.

Figure 3-17 Side-mounted IR Object Detection Circuits

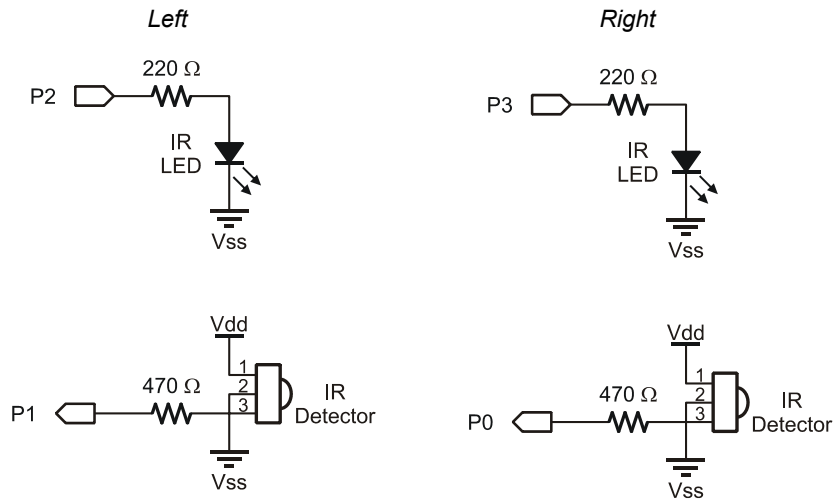

3

Figure 3-18 Wiring Diagram

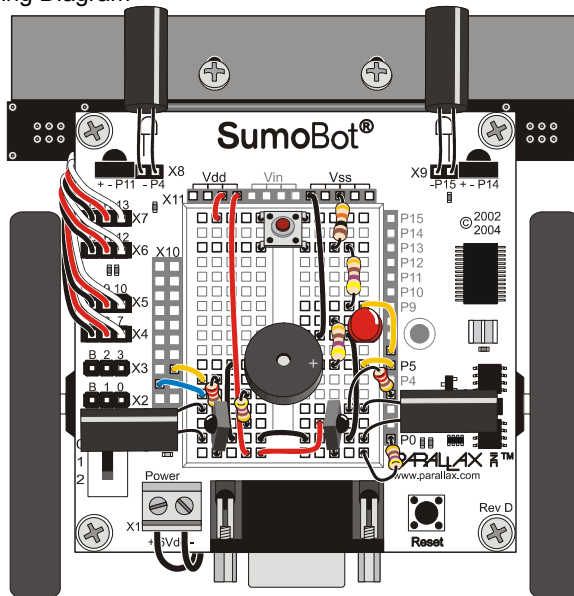

You will see that `TestSideIrObjectDetectors.bs2` is just a modified version of `TestFrontIrObjectDetectors.bs2`. Different `PIN` directives for the side mounted IR LEDs and receivers are declared, likewise for bit variables that store the IR receivers' output states. All of these different names are also updated in the `FREQOUT` commands, `IF . . . THEN` statements, and so on.

Figure 3-19 shows the detection pattern for the side mounted IR object detectors. For best chances of detection, the object should be facing the beam, not at an angle to it.

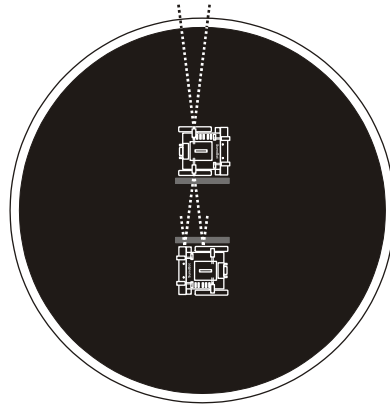

Figure 3-19
Object Detection on
the Sides

- √ Enter, save, and run `TestSideIrObjectDetectors.bs2`.
- √ Make sure the side mounted IR detectors are not pointing at any nearby objects. They may be quite sensitive, detecting white walls up to 1 or even 2 meters away.
- √ Verify that each object detector displays a 0 when an object is not detected.
- √ Place the other SumoBot in the IR detectors beam at a distance of 10 cm. Verify that it causes the Debug Terminal to display a 1 instead of a 0, indicating that the SumoBot has been detected on that side.
- √ If the IR detector circuits are not functioning as expected, repeat the troubleshooting steps in this chapter's Activity #1.

Your Turn - Testing All Four

Your SumoBot will eventually need to check and process information from all four IR object detectors each time through the Main Routine's `DO...LOOP`. In this case, it's a matter of incorporating elements from the IR object detector programs from this activity and Activity #1 into a single program. If you start with one of the programs, you can copy the following elements from the other program: `PIN` directives, variable declarations, `FREQOUT` commands and statements that set variables equal to pin names. After that, all that remains is modifying a couple of `DEBUG` commands.

- √ Save a copy of `TestSideIrObjectDetectors.bs2` as `TestAllIrObjectDetectors.bs2`.
- √ Copy all the elements you need from `TestFrontIrObjectDetectors.bs2` into your new program.
- √ Modify the `DEBUG` commands to display all the object detection bits.
- √ Test and troubleshoot until you've got it working.
- √ Save the modified program.

ACTIVITY #6: TESTING ALL SENSORS

This activity combines portions of test code that have already been developed for the following sensors into one program:

- Front IR object detectors
- Side IR object detectors
- Front QTI line sensors
- Pushbutton

Combining Programs

So far, the SumoBot has seven sensors: 2 QTI line sensors, 4 IR object detectors, and 1 pushbutton. Each has a test program that displays binary values for these sensors, either one at a time or in pairs. This next example combines them into a master program that stores the state of each sensor via a series of subroutines, then displays them all with a single `DEBUG` command. This can actually be done with minimal additions, effort, and debugging.

- √ Start by opening all of the following programs:
 - TestLedSpeaker.bs2
 - TestPushButton.bs2
 - TestFrontIrObjectDetectors.bs2
 - QtiPulseDecayTrick.bs2
 - TestSideIrObjectDetectors.bs2
- √ Save QtiPulseDecayTrick.bs2 as TestAllSensors.bs2
- √ Copy and paste the I/O definitions and variables from the other programs into your new program.
- √ Add one more bit variable that was not found in the other programs, to store the state of the pushbutton:

```
pushbutton    VAR    Bit
```

- √ Make subroutines for the speaker, IR detectors, and QTI detectors from the functional portions of their test programs. If the actual work of a sensor is done in the program's Main Routine, (like IR object detection), paste that part of the routine into a subroutine. For example, a `Read_Object_Detectors` subroutine could take four lines from the Main Routine of `TestFrontIrObjectDetectors.bs2`, and four more from `TestSideIrObjectDetectors.bs2`.

```
Read_Object_Detectors:
```

```
FREQOUT IrLedRS, 1, IrFreq           ' Right side IR LED headlight
irRS = ~IrSenseRS                   ' Save right side IR receiver

FREQOUT IrLedRF, 1, IrFreq           ' Repeat for right-front
irRF = ~IrSenseRF

FREQOUT IrLedLF, 1, IrFreq           ' Repeat for left-front
irLF = ~IrSenseLF

FREQOUT IrLedLS, 1, IrFreq           ' Repeat for left side
irLS = ~IrSenseLS

RETURN
```

The subroutine for the pushbutton needs a different approach. Remember that `pbSense` and `DummyPin` both reference P6, which is serving two purposes. It's getting used as an output when `DummyPin` sends the `PULSOUT` command pulses from the `Read_Line_Sensors` subroutine. For P6 to next be used to monitor the pushbutton, it

has to be changed back to an input first. So, the Main Routine of TestPushButton.bs2 will not serve our purpose, but this simple subroutine will.

- √ Add a **Read_Pushbutton** subroutine:

```
Read_Pushbutton:
    INPUT pbSense                ' Set I/O pin to input
    pushbutton = pbSense        ' Store state of pbSense
    RETURN
```

Some of the initialization routines will not be necessary. Others, like **Calibrate_Qtis** are crucial. It's important to pick and choose what you'll need for both the Initialization and Main Routine. You'll need to make sure to call all the subroutines and display only the relevant values.

- √ Construct an Initialization section and Main Routine that will make your program function.
- √ Test and troubleshoot it.
- √ Convert all active low bit variables to active high.
- √ Compare what you came up with to the TestAllSensors.bs2 below.

Example Program: TestAllSensors.bs2

- √ Run and test TestAllSensors.bs2.

```
' -----[ Title ]-----
' Applied Robotics with the SumoBot - TestAllSensors.bs2
' This program is a combination of the following:
'
' - QtiPulseDecayTrick.bs2
' - TestFrontIrObjectDetectors.bs2
' - TestSideIrObjectDetectors.bs2
' - TestPushButton.bs2
' - TestLedSpeaker.bs2
'
' Important: You must start with the QTIs seeing black.
'
' {$STAMP BS2}                ' Target = BASIC Stamp 2
' {$PBASIC 2.5}              ' Language = PBASIC 2.5
' -----[ I/O Definitions ]-----
```



```

qtiPwrLeft    PIN    10    ' Left QTI on/off pin P10
qtiSigLeft    PIN    9      ' Left QTI signal pin P9

qtiPwrRight   PIN    7      ' Right QTI on/off pin P7
qtiSigRight   PIN    8      ' Right QTI signal pin P8

DummyPin      PIN    6      ' I/O pin for pulse-decay P6

IrLedLF       PIN    4      ' Left IR LED connected to P4
IrSenseLF     PIN    11     ' Left IR detector to P11

IrLedRF       PIN    15     ' Right IR LED connected to P15
IrSenseRF     PIN    14     ' Right IR detector to P14

IrLedLS       PIN    2      ' Left IR LED connected to P2
IrSenseLS     PIN    1      ' Left IR detector to P1

IrLedRS       PIN    3      ' Right IR LED connected to P3
IrSenseRS     PIN    0      ' Right IR detector to P0

pbSense       PIN    6      ' Pushbutton connected to P6

LedSpeaker    PIN    5      ' LED/speaker connected to P5

' -----[ Constants ]-----
IrFreq        CON      38500    ' IR LED transmit frequency

' -----[ Variables ]-----
qtiLeft       VAR      Word     ' Stores left QTI time
qtiRight      VAR      Word     ' Stores right QTI time

qtiThreshold  VAR      Word     ' Stores black/white threshold

irLS          VAR      Bit      ' State of Left Side IR
irLF          VAR      Bit      ' State of Left Front IR
irRF          VAR      Bit      ' State of Right Front IR
irRS          VAR      Bit      ' State of Right Side IR

qtiStateLeft  VAR      Bit      ' Stores snapshot of QtiSigLeft
qtiStateRight VAR      Bit      ' Stores snapshot of QtiSigRight

pushbutton    VAR      Bit      ' Stores pushbutton state

' -----[ Initialization ]-----
GOSUB Calibrate_Qtis    ' Determine b/w threshold
DEBUG CLS              ' Clear Debug Terminal

```

```

' -----[ Main Routine ]-----
DO                                ' DO...LOOP repeats indefinitely

  GOSUB Read_Line_Sensors         ' Look for lines
  GOSUB Read_Object_Detectors     ' Look for objects
  GOSUB Read_Pushbutton          ' Check pushbutton

  DEBUG HOME,                    ' Display all sensors states
    ? irLS,
    ? irLF,
    ? irRF,
    ? irRS,
    ? qtiStateLeft,
    ? qtiStateRight,
    ? pushbutton

  PAUSE 100                       ' Delay for slower PCs

LOOP

' -----[ Subroutine - Calibrate_Qtis ]-----
Calibrate_Qtis:

  HIGH qtiPwrLeft                ' Turn left QTI on
  HIGH qtiSigLeft                ' Discharge capacitor
  PAUSE 1
  RCTIME qtiSigLeft, 1, qtiLeft  ' Measure charge time
  LOW qtiPwrLeft                 ' Turn left QTI off

  HIGH qtiPwrRight               ' Turn right QTI on
  HIGH qtiSigRight               ' Discharge capacitor
  PAUSE 1
  RCTIME qtiSigRight, 1, qtiRight ' Measure charge time

  GOSUB Read_Line_Sensors        ' Get reflection values
  qtiThreshold = (qtiLeft + qtiRight) / 2 ' Calculate average
  qtiThreshold = qtiThreshold / 4 ' Take 1/4 average

  IF qtiThreshold > 220 THEN     ' Account for code overhead
    qtiThreshold = qtiThreshold - 220
  ELSE
    qtiThreshold = 0
  ENDIF

  RETURN

' -----[ Subroutine - Read_Line_Sensors ]-----
Read_Line_Sensors:

```

```

HIGH qtiPwrLeft           ' Turn on QTIS
HIGH qtiPwrRight          ' Push signal voltages to 5 V
HIGH qtiSigLeft           '
HIGH qtiSigRight          '
PAUSE 1                   ' Wait 1 ms for capacitors

INPUT qtiSigLeft          ' Start the decays
INPUT qtiSigRight         '
PULSOUT DummyPin, qtiThreshold ' Wait for threshold time

qtiStateLeft = ~ qtiSigLeft ' Snapshot of QTI signal states
qtiStateRight = ~ qtiSigRight

LOW qtiPwrLeft           ' Turn off QTIS
LOW qtiPwrRight

RETURN

' -----[ Subroutine - Read_Object_Detectors ]-----
Read_Object_Detectors:

  FREQOUT IrLedRS, 1, IrFreq           ' Right side IR LED headlight
  irRS = ~IrSenseRS                   ' Save right side IR receiver

  FREQOUT IrLedRF, 1, IrFreq           ' Repeat for right-front
  irRF = ~IrSenseRF

  FREQOUT IrLedLF, 1, IrFreq           ' Repeat for left-front
  irLF = ~IrSenseLF

  FREQOUT IrLedLS, 1, IrFreq           ' Repeat for left side
  irLS = ~IrSenseLS

RETURN

' -----[ Subroutine - Read_Pushbutton ]-----
Read_Pushbutton:

  input pbSense
  pushbutton = pbSense                 ' Store state of pbSense

RETURN

```

Your Turn - Cleaning up Names

These variable declaration names have some room for improvement:

```

irLS          VAR    Bit           ' State of Left Side IR
irLF          VAR    Bit           ' State of Left Front IR
irRF          VAR    Bit           ' State of Right Front IR
irRS          VAR    Bit           ' State of Right Side IR

qtiStateLeft  VAR    Bit           ' Stores snapshot of QtiSigLeft
qtiStateRight VAR    Bit           ' Stores snapshot of QtiSigRight
    
```

The main problem is that they are not really consistent. The object detector variables are pretty good, there's **irLF** for IR-detector-left-front (LF), right-front(RF), and so on. The **qtiState** variables don't match the object variable's name conventions, but they should. If you change it here, you should make sure that every instance in the program is also changed. This is where the BASIC Stamp Editor's Edit -> Find/Replace feature comes in handy.

- √ Save TestAllSensors as TestAllSensorsYourTurn.bs2.
- √ In the BASIC Stamp Editor, click Edit and select Find/Replace.
- √ Enter **qtiStateLeft** into the Find field and **qtiLF** into the replace field as shown in Figure 3-20.

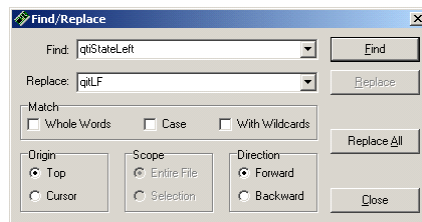

Figure 3-20
Find/Replace
Window

- √ Click Replace all. A message displaying the number of replacements should tell you how many changes were made as shown in Figure 3-21.

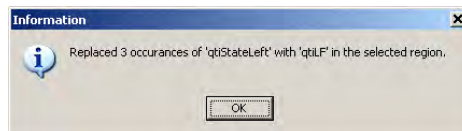

Figure 3-21
Information Window

- √ Repeat by using this feature to change `qtiStateLeft` to `qtiLF`.
- √ Some of the comments may now be out of alignment. Go through the program and insert spaces to line the side comments back up to column 46.
- √ Save your modified program; you will need it in the next couple activities.

ACTIVITY #7: ORGANIZING SENSORS WITH FLAG BITS

Storing each sensor value as an individual bit is great for decision making, especially if you want to isolate only one or two variables. In other cases, it's better to have all your bits in a larger variable. It makes it easier for your program to analyze patterns in the sensor flags. With PBASIC, you can have it both ways. This activity demonstrates how to declare a sensors variable, and then declare individual flag bits within that variable.

Bit Declarations inside a Byte

By storing all your flag bits in a larger variable, they are still accessible as individual values, but they are also accessible as a group for pattern analysis. It doesn't make programming any more difficult. In fact, with PBASIC all you have to do is declare a byte variable, and then declare the names of each individual bit in the byte.

For example, here are the 7 bit-variable declarations from `TestAllSensorsYourTurn.bs2`.

```

irLS          VAR    Bit           ' State of Left Side IR
irLF          VAR    Bit           ' State of Left Front IR
irRF          VAR    Bit           ' State of Right Front IR
irRS          VAR    Bit           ' State of Right Side IR

qtiLF        VAR    Bit           ' Stores snapshot of QtiSigLeft
qtiRF        VAR    Bit           ' Stores snapshot of QtiSigRight

pushbutton   VAR    Bit           ' Stores pushbutton state

```

To arrange these in a byte, simply declare the byte variable, and then declare each bit as a member of the byte variable. For example, if the byte is named `sensors`, `irRS` can be `sensors.BIT0`, `irRF` can be `sensors.BIT1`, and so on. Here is the entire series of variable declarations within a single `sensors` byte variable:

```

sensors      VAR    Byte           ' Sensor flags byte

pushbutton   VAR    sensors.BIT6   ' Stores pushbutton state

qtiLF        VAR    sensors.BIT5   ' Stores snapshot of QtiSigLeft
qtiRF        VAR    sensors.BIT4   ' Stores snapshot of QtiSigRight

```

```

irLS          VAR    sensors.BIT3    ' State of Left Side IR
irLF          VAR    sensors.BIT2    ' State of Right Side IR
irRF          VAR    sensors.BIT1    ' State of Right Front IR
irRS          VAR    sensors.BIT0    ' State of Right Side IR

```

The best thing about this arrangement is that no other changes in the program have to be made. The program will still function normally, and you can display each bit value as before.

- √ Save TestAllSensorsYourTurn.bs2 as SensorsWithFlagsByte.bs2.
- √ Modify the variable declarations as explained in this activity.
- √ Test the program and verify that it still works the same.

Your Turn - Working with the Sensors Byte

Here is an alternate Initialization and Main Routine you can try to see how a byte can show you different patterns of bits (1s and 0s). A **DEBUG** command in the Initialization builds a display heading to label each bit in the sensors variable, with a reference to the sensor whose status that bit stores. Then a **DO...LOOP** in the Main Routine constantly updates the value of the **sensors** variable, and displays in a second **DEBUG** command.

```

' -----[ Initialization ]-----
GOSUB Calibrate_Qtis          ' Determine b/w threshold

' Display heading
DEBUG CLS, " PB", CR,          ' Pushbutton
      " |QTI",CR,              ' QTI line sensors
      " |||IROD",CR,          ' Infrared Object Detectors
      " |||||",CR,
      CR,                      ' Sensors byte goes here
      " |||||", CR,
      " LRLRR", CR,          ' Left/right
      " FFSFFS"              ' Front/side

' -----[ Main Routine ]-----

DO                             ' DO...LOOP repeats indefinitely
  GOSUB Read_Line_Sensors      ' Look for lines
  GOSUB Read_Object_Detectors  ' Look for objects
  GOSUB Read_Pushbutton        ' Check pushbutton

  DEBUG CRSRXY, 0, 4, BIN8 sensors ' Display Sensors Variable
  PAUSE 100                    ' Delay for slower PCs
LOOP

```

Figure 3-22 shows an example of how these modified routines display the contents of the `sensors` byte. But first let's look at this line for a moment:

```
DEBUG CRSRXY, 0, 4, BIN8 sensors
```

`DEBUG CRSRXY, 0, 4`, places the Debug Terminal cursor at column 0, row 4 (the top row is row 0) right inside the display heading built by the Initialization `DEBUG` command. `BIN8 sensors` displays the value of `sensors` as an 8-digit binary number, allowing us to view each bit, and therefore the status of each sensor's I/O pin.

The bit pattern in Figure 3-22 indicates that the left and right front IR detectors see an object, making it a good time for your SumoBot to lunge forward. In the next chapter, your programs will examine this variable, sometimes for patterns, and other times for changes in certain groups of bits.

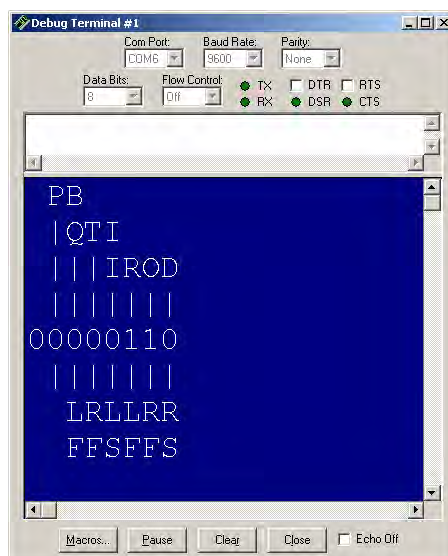

Figure 3-22
The `sensors` Byte

The left front (LF) and right front (RF) infrared object detectors (IROD) have detected objects

- √ Save `SensorsWithFlagsByte.bs2` as `SensorsByteDisplay.bs2`.
- √ Replace the Initialization and Main Routine with the ones above.
- √ Save and run the program.

- √ In order from **BIT0** to **BIT6**, test the sensors in this order: infrared object detectors - right side, right front, left front, left side. QTI line sensors - right front, left front, pushbutton.

ACTIVITY #8: VARIABLE MANAGEMENT FOR LARGE PROGRAMS

When you have a project with a lot of sensors and programmed machine reactions, variable space can become pretty tight. For example, the program in the previous activity uses three words and one byte. There's one byte to take each QTI reading, and another to store the QTI threshold. All three of these bytes are used at the beginning of the program, but only one (threshold) is accessed repeatedly as the program runs. Since threshold isn't even changed repeatedly as the program runs, it's not necessarily the best use of a RAM variable either.

This activity uses the techniques introduced in Chapter 2, Activity #2 to use and reuse temporary variables. As you go through the activities in this book, you will use the same few temporary variables to monitor sensors, control servos, log data, and perform a variety of maneuvers. In virtually every subroutine you build to perform these functions, the same few variables will be used in different ways. Even after the activities in this book, you can continue to add functionality to your SumoBot, without worrying that the next sensor might take up too much RAM.

Incorporating Temporary Variables into SensorsWithByteDisplay.bs2

It's important to modify the sensor testing program (SensorsWithByteDisplay.bs2) so that it uses the memory management techniques introduced in ThreeVariablesManyJobs.bs2. Specifically, it has to use and re-use temporary variables and use EEPROM to store and access values that don't change frequently. After the program has been modified, features like more sensors, servo control, navigation, and datalogging can be added in many cases without ever having to declare any more RAM variables.

- √ Start by saving SensorsWithByteDisplay.bs2 as SensorsWithTempVariables.bs2.
- √ Next, the **qtiLeft**, **qtiRight**, and **qtiThreshold** variable declarations need to be commented out. In place of these three variables, you can use two word variables - **temp** (short for temporary) and **multi** (short for multipurpose).

```
' -----[ Variables ]-----  
  
' qtiLeft          VAR      Word      ' Stores left QTI time  
' qtiRight         VAR      Word      ' Stores right QTI time
```



```

' qtiThreshold  VAR      Word      ' Stores black/white threshold
temp           VAR      Word      ' <--- New temporary variable
multi          VAR      Word      ' <--- New multipurpose variable

```

As mentioned earlier, a variable doesn't have to store the QTI decay black/white threshold value because it doesn't change after it is set at the beginning of the program. This makes it a prime candidate for EEPROM storage. We can use a **DATA** directive to set aside a word-size variable to hold this threshold value.

- √ Add this **DATA** directive to give this EEPROM address the *Symbol* name **QtiThresh**.

```

' -----[ EEPROM Data ]-----
QtiThresh      DATA      Word 0      ' Word for QTI threshold time

```

Even though the **DATA** directive writes a 0 to this EEPROM location when the program is downloaded, a **WRITE** command can change this value after the program starts running. Any value that is stored in EEPROM will remain there even if the power is disconnected from the SumoBot. The only things that can change that value are another **WRITE** command, or a download with a **DATA** directive that overwrites it.

All commands in the `Calibrate_Qtis` subroutine that involve the `qtiLeft`, `qtiRight`, or `qtiThreshold` variables can be replaced with commands that use `temp` and `multi`. Each command that got replaced was commented, with an apostrophe ' placed to the left of it. Each command that was added has a comment to the right with either ' <--- **Add** or ' <--- **New**. Notice that `multi` and `temp` are also used to calculate the threshold time. Notice also that the threshold value is then copied from the `multi` variable to the byte at the `QtiThresh` address in EEPROM.

- √ Go through and examine each commented command and its replacement in this entire subroutine.

```

' -----[ Subroutine - Calibrate_Qtis ]-----
Calibrate_Qtis:
HIGH qtiPwrLeft           ' Turn left QTI on
HIGH qtiSigLeft          ' Discharge capacitor
PAUSE 1
'   RCTIME qtiSigLeft, 1, qtiLeft      ' Measure charge time

```

```

    RCTIME qtiSigLeft, 1, temp          ' <--- New measure charge time

    LOW qtiPwrLeft                      ' Turn left QTI off
    multi = temp                        ' <--- Add

    HIGH qtiPwrRight                    ' Turn right QTI on
    HIGH qtiSigRight                    ' Discharge capacitor
    PAUSE 1
    ' RCTIME qtiSigRight, 1, qtiRight    ' Measure charge time
    RCTIME qtiSigRight, 1, temp          ' <--- New measure charge time

    ' qtiThreshold = (qtiLeft + qtiRight) / 2    ' Calculate average
    multi = (multi + temp) / 2          ' <--- New calculate average

    ' qtiThreshold = qtiThreshold / 4           ' Take 1/4 average
    multi = multi / 4                   ' <--- New take 1/4 average

    'IF qtiThreshold > 220 THEN              ' Account for code overhead
    '  qtiThreshold = qtiThreshold - 220
    ' ELSE
    '   qtiThreshold = 0
    ' ENDIF

    IF multi > 220 THEN                    ' <--- New
    multi = multi - 220                    ' <--- New
    ELSE                                    ' <--- New
    threshold = 0                          ' <--- New
    ENDIF                                   ' <--- New

    WRITE QtiThresh, multi                 ' <--- New threshold to EEPROM

    RETURN

```

Since there's no more `qtiThreshold` variable and the value is instead stored at the `QtiThresh` address in EEPROM, the `Read_Line_Sensors` subroutine will have to be changed too. A `READ` command is used to copy the `QtiThresh` value from EEPROM to the `temp` variable. Then, `PULSOUT DummyPin, temp` replaces `PULSOUT DummyPIN, qtiThreshold`.

```

' -----[ Subroutine - Read_Line_Sensors ]-----
Read_Line_Sensors:
.
.
.
    READ QtiThresh, Word temp            ' <-- Add get threshold time

    INPUT qtiSigLeft                     ' Start the decays
    INPUT qtiSigRight

```

```

' PULSOUT DummyPin, qtiThreshold      ' Wait for threshold time
PULSOUT DummyPin, temp                ' <--- New wait threshold time

qtiLF = ~qtiSigLeft                   ' Snapshot of QTI signal states
qtiRF = ~qtiSigRight
.
.
.

```

Remember, the goal of all this work is to make the program more easily expandable. The other goal is to make it so that you can move parts of this program to other programs that follow the same conventions. However, it still has to perform the same functions that it did before the adjustments.

Example Program: SensorsWithTempVariables.bs2

- √ Enter, save, and run SensorsWithTempVariables.bs2
- √ Verify that the QTIs work the same as before.

```

' -----[ Title ]-----
' Applied Robotics with the SumoBot - SensorsWithTempVariables.bs2
' Demonstrates the use of a temporary and multipurpose variable in conjunction
' with DATA, WRITE, and READ for calculating, storing, and using the qti
' threshold value.

' {$STAMP BS2}                ' Target = BASIC Stamp 2
' {$PBASIC 2.5}              ' Language = PBASIC 2.5

' -----[ I/O Definitions ]-----

qtiPwrLeft    PIN    10      ' Left QTI on/off pin P10
qtiSigLeft    PIN    9       ' Left QTI signal pin P9

qtiPwrRight   PIN    7       ' Right QTI on/off pin P7
qtiSigRight   PIN    8       ' Right QTI signal pin P8

DummyPin      PIN    6       ' I/O pin for pulse-decay P6

IrLedLF       PIN    4       ' Left IR LED connected to P4
IrSenseLF     PIN    11      ' Left IR detector to P11

IrLedRF       PIN    15      ' Right IR LED connected to P15
IrSenseRF     PIN    14      ' Right IR detector to P14

IrLedLS       PIN    2       ' Left IR LED connected to P2
IrSenseLS     PIN    1       ' Left IR detector to P1

```

```

IrLedRS      PIN      3          ' Right IR LED connected to P3
IrSenseRS    PIN      0          ' Right IR detector to P0

pbSense      PIN      6          ' Pushbutton connected to P6

LedSpeaker   PIN      5          ' LED/speaker connected to P5

' -----[ Constants ]-----

IrFreq       CON      38500       ' IR LED transmit frequency

' -----[ Variables ]-----

' qtiLeft     VAR      Word        ' Stores left QTI time
' qtiRight    VAR      Word        ' Stores right QTI time
' qtiThreshold VAR     Word        ' Stores black/white threshold

temp         VAR      Word        ' <--- New temporary variable
multi        VAR      Word        ' <--- New multipurpose variable

sensors      VAR      Byte        ' Sensor flags byte

pushbutton   VAR      sensors.BIT6 ' Stores pushbutton state

qtiLF        VAR      sensors.BIT5 ' Stores snapshot of QtiSigLeft
qtiRF        VAR      sensors.BIT4 ' Stores snapshot of QtiSigRight

irLS         VAR      sensors.BIT3 ' State of Left Side IR
irLF         VAR      sensors.BIT2 ' State of Left Front IR
irRF         VAR      sensors.BIT1 ' State of Right Front IR
irRS         VAR      sensors.BIT0 ' State of Right Side IR

' -----[ Initialization ]-----

GOSUB Calibrate_Qtis          ' Determine b/w threshold

' Display heading
DEBUG CLS, " PB", CR,          ' Pushbutton
          " |QTI",CR,          ' QTI line sensors
          " |||IROD",CR,       ' Infrared Object Detectors
          " |||||",CR,
          CR,                  ' Sensors byte goes here
          " |||||", CR,
          " LRLRR", CR,
          " FFSFFS"           ' Left/right
                               ' Front/side

' -----[ EEPROM Data ]-----

QtiThresh    DATA     Word 0    ' Word for QTI threshold time

' -----[ Main Routine ]-----

```

```

DO                                     ' DO...LOOP repeats indefinitely

GOSUB Read_Line_Sensors                ' Look for lines
GOSUB Read_Object_Detectors            ' Look for objects
GOSUB Read_Pushbutton                  ' Check pushbutton

DEBUG CRSRXY, 0, 4, BIN8 sensors       ' Display Sensors Variable
PAUSE 100                              ' Delay for slower PCs

LOOP

' -----[ Subroutine - Calibrate_Qtis ]-----
Calibrate_Qtis:

HIGH qtiPwrLeft                        ' Turn left QTI on
HIGH qtiSigLeft                        ' Discharge capacitor
PAUSE 1

'   RCTIME qtiSigLeft, 1, qtiLeft      ' Measure charge time
RCTIME qtiSigLeft, 1, temp              ' <--- New measure charge time

LOW qtiPwrLeft                          ' Turn left QTI off
multi = temp                            ' <--- Add

HIGH qtiPwrRight                        ' Turn right QTI on
HIGH qtiSigRight                        ' Discharge capacitor
PAUSE 1
'   RCTIME qtiSigRight, 1, qtiRight    ' Measure charge time
RCTIME qtiSigRight, 1, temp              ' <--- New measure charge time

'   qtiThreshold = (qtiLeft + qtiRight) / 2   ' Calculate average
multi = (multi + temp) / 2              ' <--- New calculate average

'   qtiThreshold = qtiThreshold / 4           ' Take 1/4 average
multi = multi / 4                       ' <--- New take 1/4 average

'   IF threshold > 220 THEN                 ' Account for code overhead
'     threshold = threshold - 220
'   ELSE
'     threshold = 0
'   ENDIF

IF multi > 220 THEN                       ' <--- New
  multi = multi - 220                     ' <--- New
ELSE                                       ' <--- New
  multi = 0                               ' <--- New
ENDIF                                     ' <--- New

```

```

WRITE QtiThresh, Word multi          ' <--- New threshold to EEPROM
RETURN

' -----[ Subroutine - Read_Line_Sensors ]-----
Read_Line_Sensors:

HIGH qtiPwrLeft                      ' Turn on QTIs
HIGH qtiPwrRight
HIGH qtiSigLeft                      ' Push signal voltages to 5 V
HIGH qtiSigRight
PAUSE 1                              ' Wait 1 ms for capacitors

READ QtiThresh, Word temp            ' <-- Add get threshold time

INPUT qtiSigLeft                    ' Start the decays
INPUT qtiSigRight

' PULSOUT DummyPin, qtiThreshold     ' Wait for threshold time
PULSOUT DummyPin, temp              ' <--- New wait threshold time

qtiLF = ~qtiSigLeft                ' Snapshot of QTI signal states
qtiRF = ~qtiSigRight

LOW qtiPwrLeft                      ' Turn off QTIS
LOW qtiPwrRight

RETURN

' -----[ Subroutine - Read_Object_Detectors ]-----
Read_Object_Detectors:

FREQUENCY IrLedRS, 1, IrFreq        ' Right side IR LED headlight
irRS = ~IrSenseRS                  ' Save right side IR receiver

FREQUENCY IrLedRF, 1, IrFreq        ' Repeat for right-front
irRF = ~IrSenseRF

FREQUENCY IrLedLF, 1, IrFreq        ' Repeat for left-front
irLF = ~IrSenseLF

FREQUENCY IrLedLS, 1, IrFreq        ' Repeat for left side
irLS = ~IrSenseLS

RETURN

' -----[ Subroutine - Read_Pushbutton ]-----
Read_Pushbutton:

```

```
INPUT pbSense
pushbutton = pbSense           ' Store state of pbSense

RETURN
```

3**Your Turn - Program Cleanup**

- √ Review the commented lines of code and their replacements.
- √ Remove the commented lines of code.
- √ Run the program and verify that it still works properly.

SUMMARY

This chapter reviewed how the SumoBot's IR detectors work, then introduced basic IR detector testing along with IR interference, electrical continuity, and IR receiver frequency response tests. Using these tests will help ensure that the SumoBot's IR detectors are reliable, and more likely to detect an opponent than lead the SumoBot on a snipe hunt. Side-mounted IR object detectors were added to the breadboard to give the SumoBot peripheral vision.

This chapter also reviewed how QTI line sensors work, and then introduced a technique you can use in your programs to read multiple QTI sensors, all in less than the time it takes to read a single QTI sensor on a black surface. Self calibration techniques for QTI line sensors were reviewed and refined so that your SumoBot can automatically adjust to different sumo ring surfaces and ambient lighting conditions.

Programs were developed to read and track the values of each of the seven sensors (4 IR detectors, 2 QTI sensors, and 1 pushbutton). A flags variable was introduced as a way of storing the state of each of the individual sensor bits for pattern analysis. Temporary variables for storage and counting were then incorporated into the program so that each subroutine doesn't require its own special set of variables, which is an unnecessary use of variable space.

Questions

1. What label designates the header with the front-left IR detector?
2. What connections does the SumoBot board make to the header with the front-left IR detector that you don't have to build on a breadboard?
3. What does `FREQOUT 4, 1, 38500` do?
4. What does `FREQOUT 14, 1, 38500` do?
5. Are the SumoBot's IR receivers active-low or active-high output devices?
6. What is a ballast?
7. What's the main coding difference between "sniffing" for IR interference and IR object detection?
8. What is an interruption in electrical continuity?
9. What problems can occur if your SumoBot's IR object detectors are set for maximum sensitivity?
10. What does "frequency response" refer to?

11. What factors should you keep in mind when selecting a frequency for a given SumoBot ring?
12. What label designates the header with the front-left QTI sensor?
13. What connections does the SumoBot board make to the header with the front-left QTI Sensor that you don't have to build on a breadboard?
14. How does the BASIC Stamp turn the power to a QTI on and off?
15. How many components are on the QTI sensor?
16. What water analogy was used for the infrared transistor inside the QRD1114?
17. Does the QRD1114 need a 38.5 kHz infrared signal?
18. Regarding Figure 3-11 on page 99, why does V_0 decay more quickly when the infrared transistor receives more IR?
19. Regarding Figure 3-11 on page 99, what does each of the three downward curves indicate?
20. How does voltage decay relate to the amount of infrared a surface reflects? Use black and white as examples.
21. What are the measurement units of `RCTIME` and `PULSOUT` in the BASIC Stamp 2?
22. What code block can you use to improve the accuracy of the pulse-decay trick?
23. With the pulse-decay trick, are the QTIs active-high or active low?
24. How do the circuits from the side-mounted IR object detectors differ from the front-mounted ones?
25. How much more memory does it take to use a sensors variable to store all the individual sensor bits?

Exercises

1. Write a routine that counts the number of IR interferences detected in a minute.
2. Write a routine that tests the IR receiver's frequency response at increments of 250 instead of 500.
3. Calculate the value threshold will store in `QtiSelfCalibrate.bs2` if the white measurement is 100 and the black measurement is 2000.
4. Expand the band of frequencies examined by `TestFrequencyResponse.bs2` from $36 \text{ kHz} \leq f \leq 42 \text{ kHz}$ to $33 \text{ kHz} \leq f \leq 45 \text{ kHz}$
5. Modify `TestFrontQtiLineSensors.bs2` so that it notifies you if tilt is detected.
6. Calculate the time it would take 3 QTIs to each take measurements that average `RCTIME` measurements of 2500.
7. Modify the `Your Turn` program from Activity #7 so that it displays a 1 in `sensors.BIT7` if all IR detectors simultaneously detect an object.

Projects

1. Write a program that beeps at different notes to tell you which sensor it detects.
2. Place an object on the SumoBot's left at a distance outside the SumoBot Competition Ring that the SumoBot can detect with only its most sensitive IR object detection frequencies. Place the other SumoBot on the right side. Write a self-calibrating routine to select the frequency that most effectively detects the SumoBot, but not the object outside the competition ring.

Chapter #4: Navigation Tips

Effectively using four object detectors and two QTI line sensors for SumoBot navigation can seem a little daunting at first, especially when you consider that there are 64 different possible combinations of detected and not detected that you can get from this array. It turns out that you can reduce all these possibilities to a very simple **IF...ELSEIF...ELSE...ENDIF** statement. In fact, just an **IF**, six **ELSIFs**, and one **ELSE** can control the whole show and give you a highly functional wrestling program.

The **IF**, all the **ELSEIFs** and the **ELSE** conditions in the final program call subroutines that do specific maneuvers until either a sensor condition is detected indicating the subroutine succeeded, or the allowed amount of time for the subroutine to execute the maneuver has expired. It makes the SumoBot's behavior both predictable and automated. This chapter demonstrates the various building blocks that go into a program that simplifies the SumoBot's decision process and automates maneuver's responses to sensor events.

SENSOR FLAGS AND NAVIGATION STATES

There are several ingredients to building a program that makes a lot of different sensors and maneuvers easy to manage. First, build a subroutine that makes selecting servo pulse durations fully automated. All your program should have to do is set a variable equal to a maneuver name, and then call the servo control subroutine. Second, build a subroutine that calls both the servo control subroutine and updates all the sensors. That way, after your program has picked its maneuver, the **sensors** variable can be completely updated between each servo pulse. Third, construct independent navigation states. Each navigation state should be a subroutine that does a job with no further intervention until it has either succeeded or its time for the maneuver has expired. Finally, construct an **IF...THEN** statement that checks and responds to the most important sensor flags first, and then goes down a list of possible conditions that the SumoBot should react to. This **IF...THEN** statement simply responds to each sensor condition by calling the navigation subroutine that is designed to respond to that condition.

It takes a few steps to get to the final form of the program, starting as always with small programs. These small programs are then converted into programs that feature sections and a common variable use convention. After several of these are built, they can be merged into a larger test program. After the test program is tested, it can be rearranged into a simplified Main Routine that makes executive decisions and then passes control to navigation subroutines.

ACTIVITY #1: SERVO CONTROL WITH LOOKUP COMMANDS

Since all the other subroutines in this book have utilized some combination of the `counter` and `temp` variables, why not make it so for servo control subroutines? This activity demonstrates a way to do it with the `LOOKUP` command.

Servo Control Review

Figure 4-1 is a repeat of Figure 1-4 from Chapter 1, Activity #1. A quick review: The left servo is connected to header X7 on the SumoBot board. The SumoBot's BASIC Stamp will send the left servo control signals from I/O pin P13. The right servo is connected to header X6. The SumoBot's BASIC Stamp will send the right servo control signals from I/O pin P12.

Figure 4-1 SumoBot Servo Connections

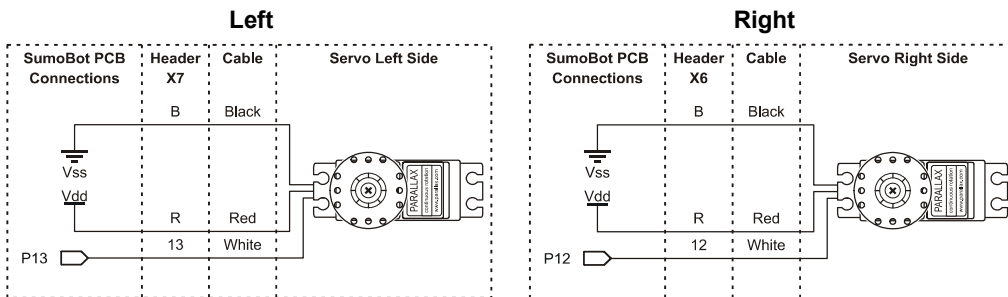

Your PBASIC programs can control each servo's speed, direction and run-times with `PULSOUT` commands inside a `FOR...NEXT` loop. Figure 4-2 shows an example. This `FOR...NEXT` loop makes the SumoBot's servos turn full speed for one second. The SumoBot's left servo, which is connected to P13 turns full speed counterclockwise while its right servo, which is connected to P12, turns full speed clockwise. This combination of wheel rotations makes the SumoBot travel forward.

Figure 4-2 The Servo Control Loop

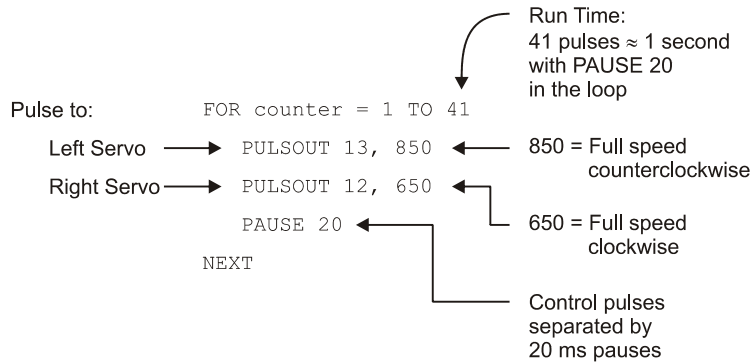

4

The `FOR...NEXT` loop's `EndValue` is the number of 1/41 second increments the servo will run. Every time through the loop takes about 24.6 ms, so 41 times through the 24.6 ms loop takes about $41 \times 0.0246 \approx 1$ second. Increasing the `FOR...NEXT` loop's `EndValue` argument to 82 would make the servos run for twice the time, about 2 seconds. Half a second of servo rotation would be an `EndValue` of 20, and so on.

Sensors will change the effective PAUSE time. When the effective `PAUSE` time has changed, it will take some experimenting to re-tune the `FOR...NEXT` loop `EndValues` to get the servo rotation times you want.

The servos have to turn opposite directions to make the SumoBot roll forward. If this seems counterintuitive, look at the SumoBot's right side. That wheel has to turn clockwise to make the SumoBot roll forward. Now look at the SumoBot's left side. That wheel has to turn counterclockwise to make the SumoBot roll forward.

Applying the same train of thought for rolling backward, the right servo has to turn counterclockwise, and the left servo has to turn clockwise. By rotating both servos the same direction, you can either make the SumoBot rotate right or left. To make the SumoBot rotate left, both wheels must turn clockwise. To make the SumoBot rotate right, both wheels must turn counterclockwise.

The graph in Figure 4-3 shows how you can use the `PULSOUT` command's `Duration` argument to control the servo's speed and direction. Recall that the `PULSOUT` `Duration` argument has units of $2 \mu\text{s}$. A pulse width of $1300 \mu\text{s}$, equal to a `PULSOUT` `Duration` of 650, is full speed clockwise. A `Duration` of 850 ($1700 \mu\text{s}$) is full speed counterclockwise. A `Duration` of 750 ($1500 \mu\text{s}$) yields no rotation.

With some experimentation, you can also control the speed of the servos too. Note from Figure 4-3 that the relationship between pulse width and rotational velocity is not simply linear. For example, a *Duration* of 700 is still pretty close to full speed clockwise, but as you increase to 710, 720, 730, and so on, there should be a noticeable reduction in speed. The closer *Duration* is to 750, the slower the servo will turn. Likewise, 800 is still pretty close to full speed counterclockwise, but as *Duration* gets closer to 750, the servo will rotate counterclockwise more slowly.

Figure 4-3 PULSOUT *Duration* vs. Rotational Velocity for Parallax Continuous Rotation Servo

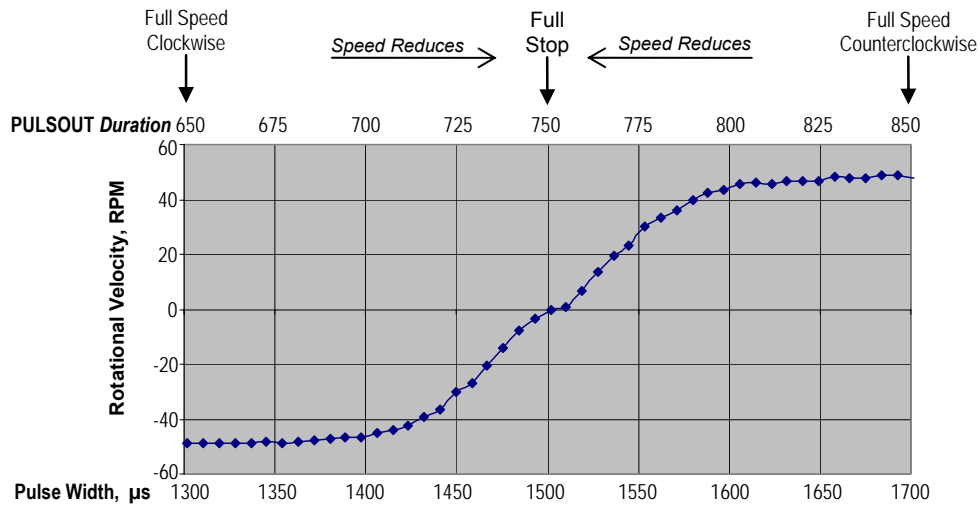

ServoControlExample.bs2 demonstrates how to use `PULSOUT Duration` and `FOR...NEXT` loop `EndValue` arguments to determine the SumoBot's maneuver and the time the SumoBot spends executing that maneuver.

Example Program: ServoControlExample.bs2

- ✓ Enter, save, and run the ServoControlExample.bs2.
- ✓ Verify that the SumoBot executes each of the maneuvers mentioned in the comments.

```
' Applied Robotics with the SumoBot - ServoControlExample.bs2

' {$STAMP BS2}
' {$PBASIC 2.5}

counter VAR byte

' SumoBot goes forward 3 seconds.
FOR counter = 1 TO 122
  PULSOUT 13, 850
  PULSOUT 12, 650
  PAUSE 20
NEXT

' SumoBot goes backward 3 seconds.
FOR counter = 1 TO 122
  PULSOUT 13, 650
  PULSOUT 12, 850
  PAUSE 20
NEXT

' SumoBot rotates left .75 seconds.
FOR counter = 1 TO 30
  PULSOUT 13, 650
  PULSOUT 12, 650
  PAUSE 20
NEXT

' SumoBot rotates right .75 seconds.
FOR counter = 1 TO 30
  PULSOUT 13, 850
  PULSOUT 12, 850
  PAUSE 20
NEXT

' SumoBot pivots right 1.5 seconds.
FOR counter = 1 TO 61
  PULSOUT 13, 850
  PULSOUT 12, 750
  PAUSE 20
NEXT

' SumoBot curves left 1.5 seconds.
FOR counter = 1 TO 61
  PULSOUT 13, 765
  PULSOUT 12, 650
  PAUSE 20
NEXT
```

Your Turn - Using PIN Definitions and Constants

Instead of the number 13 in the `PULSOUT` command's `Pin` argument, the example program can use the `PIN` directive `ServoLeft`. Likewise, the program can use `ServoRight` in place of the number 12. Since we know that 650 is the `PULSOUT Duration` for full-speed-clockwise, a good constant name for this number would be `FS_CW`. Along the same lines, 850 can be `FS_CCW` for full speed counterclockwise, and 750 can be `NO_ROT` for no rotation.

√ Add these `PIN` directives and constant declarations to the program:

```
' -----[ I/O Definitions ]-----
ServoLeft      PIN      13          ' Left servo connected to P13
ServoRight     PIN      12          ' Right servo connected to P12

' -----[ Constants ]-----

' Servo pulse width rotation constants

FS_CCW         CON      850          ' Full speed counterclockwise
FS_CW          CON      650          ' Full speed clockwise
NO_ROT         CON      750          ' No rotation
```

Here is an example of the first one updated with `PIN` directives and constant names.

```
' SumoBot goes forward 3 seconds.
FOR counter = 1 TO 122
  PULSOUT ServoLeft, FS_CCW
  PULSOUT ServoRight, FS_CW
  PAUSE 20
NEXT
```

√ Modify all the motion routines to use these constants.

LOOKUP Command Review

The `LOOKUP` command picks a value from the lookup table (the list within the square braces) and copies that value to `variable`. The value `LOOKUP` picks depends on the `Index` variable.

`LOOKUP Index, [Value1, Value2, ... ValueN], Variable`

Let's take a second look at that `LOOKUP` command from Chapter 2, Activity #4. If `counter` is 0, the `LOOKUP` command will copy 1046 to the `note` variable. If `counter` is 1, `LOOKUP` will copy 1175 to the `note` variable. If `counter` is 2, 1319 will be copied to `note`, and so on.

```
LOOKUP counter, [1046, 1175, 1319,
                 1397, 1580, 1760,
                 1976, 2093], note
```

Example Program: LookupExample.bs2

- √ Enter, save, and run `LookupExample.bs2`.
- √ Use the Debug Terminal to verify the relationship between the value `counter` stores and the number between the square brackets that gets stored in the `note` variable.

```
' Applied Robotics with the SumoBot - LookupExample.bs2
'
' {$STAMP BS2}
' {$PBASIC 2.5}

Ledspeaker PIN 5

counter VAR Byte
note     VAR Word

DEBUG "Counter  Note",CR,
      "-----  -----", CR

FOR counter = 0 TO 7
  LOOKUP counter, [1046, 1175, 1319,
                  1397, 1580, 1760,
                  1976, 2093], note
  DEBUG DEC counter, CRSRX, 9, DEC note, CR
  FREQOUT 5, 500, note
  PAUSE 25
NEXT

END
```

Your Turn

You can declare constants equal to the `note` values, and then use those constants in the lookup table.

- √ Save the example program as LookupExampleYourTurn.bs2
- √ Add these constant declarations with the `CON` directive:

```
C_6 CON 1046
D_6 CON 1175
E_6 CON 1319
F_6 CON 1397
G_6 CON 1580
A_6 CON 1760
B_6 CON 1976
C_7 CON 2093
```

- √ Change the lookup table to this:

```
LOOKUP counter, [C_6, D_6, E_6,
                 F_6, G_6, A_6,
                 B_6, C_7], note
```

- √ Run the program, and verify that it works the same as before.

A Servo Control Subroutine with the LOOKUP Command

In addition to the `counter` and `temp` variables, this activity's example program will use a nibble variable named `maneuver`:

```
maneuver      VAR      Nib      ' SumoBot travel maneuver
```

The `maneuver` variable will be set equal to various constants before calling a servo control subroutine.

```
Forward      CON      0      ' Forward
Backward     CON      1      ' Backward
RotateLeft   CON      2      ' RotateLeft
RotateRight  CON      3      ' RotateRight
```

For example, you can set `maneuver` equal to a value and then call the servo control subroutine like this:

```
maneuver = Forward
GOSUB Pulse_Servos
```

If you want to deliver 35 pulses, put it in a `FOR...NEXT` loop:

```
FOR counter = 1 TO 35      ' Forward 35 pulses
  maneuver = Forward
  GOSUB Pulse_Servos
NEXT
```

The servo control subroutine will send pulse values to the servos. Constants for full speed counterclockwise (**FS_CCW**), full speed clockwise (**FS_CW**), and no rotation (**NO_ROT**) will make the subroutine easier to write.

```

FS_CCW      CON      850      ' Full speed counterclockwise
FS_CW       CON      650      ' Full speed clockwise
NO_ROT      CON      750      ' No rotation

```

Here is the **Pulse_Servos** subroutine. Remember that **Forward** is a constant, set to 0 by a constant declaration (**Forward CON 0**). If **maneuver** is set to **Forward** before the **Pulse_Servos** subroutine is called, the **LOOKUP** command takes the zeroth element in the lookup table, and copies it to the **temp** variable. The first lookup command copies **FS_CCW** (850) to **temp**. Then **PULSOUT ServoLeft, temp** sends that pulse to the left servo, which is connected to P13. It's equivalent to **PULSOUT 13, 850**. The second **LOOKUP** and **PULSOUT** commands in the subroutine place **FS_CW** (650) into the **temp** variable. So **PULSOUT ServoRight, temp** is equivalent to **PULSOUT 12, 650**, which makes the right servo turn full speed clockwise.

```

' -----[ Subroutine - Pulse_Servos ]-----
Pulse_Servos:
' Pulse to left servo
LOOKUP maneuver, [FS_CCW, FS_CW, FS_CW, FS_CCW], temp
PULSOUT ServoLeft, temp
' Pulse to right servo
LOOKUP maneuver, [FS_CW, FS_CCW, FS_CW, FS_CCW], temp
PULSOUT ServoRight, temp
' Pause between pulses (remove when using IR object detectors + QTIs)
PAUSE 20
RETURN

```

If **maneuver** is set equal to the constant **Backward**, the **LOOKUP** command copies **FS_CW** to the **temp** variable for the **PULSOUT ServoLeft, temp** command, and **FS_CCW** to **temp** for the **PULSOUT ServoRight, temp** command. If **maneuver** is **RotateLeft** (2), **FS_CW** is copied to **temp** for both **PULSOUT** commands. Finally, if **maneuver** is **RotateRight** (3), **FS_CCW** gets copied to both **temp** variables, and the **PULSOUT** commands send 850 to the servos.

Example Program: ServoControlWithLookup.bs2

- ✓ Enter and save ServoControlWithLookup.bs2
- ✓ Move the 3-position switch on the SumoBot circuit board to position 1.
- ✓ Download the program to the SumoBot.
- ✓ Hold down the Reset button on the SumoBot circuit board, then move the 3-position switch from 1 to 2.
- ✓ Place the SumoBot on the practice ring, let go of the Reset button, and watch it navigate. It should move forward around 10 inches (25 cm), then rotate left almost 90°, then rotate right almost 180°, then rotate left almost 90° to return to the direction it was first facing. It should then continue forward and repeat the “look left, look right” jog after another 10 inches.



The usefulness of the Reset subroutine. It sure was easier to just tap that Reset button to make the SumoBot stop and wait wasn't it? All you have to do is copy and paste a few sections from TestResetButton.bs2 from Chapter 2, Activity #3 into this example program, and you'll have that functionality again.

Calibration: Your servos may perform differently, so you may need to adjust the FOR...NEXT loops' *EndValue* arguments to get your SumoBot to perform the search pattern the way it was just described.

```
' -----[ Title ]-----
' Applied Robotics with the SumoBot - ServoControlWithLookup.bs2

' {$STAMP BS2}           ' Target = BASIC Stamp 2
' {$PBASIC 2.5}         ' Language = PBASIC 2.5

' -----[ I/O Definitions ]-----

ServoLeft    PIN    13           ' Left servo connected to P13
ServoRight   PIN    12           ' Right servo connected to P12

' -----[ Constants ]-----

' SumoBot maneuver constants

Forward      CON    0           ' Forward
Backward     CON    1           ' Backward
RotateLeft   CON    2           ' Rotate in place turning left
RotateRight  CON    3           ' Rotate in place turning right

' Servo pulse width rotation constants

FS_CCW       CON    850         ' Full speed counterclockwise
FS_CW        CON    650         ' Full speed clockwise
```

```

NO_ROT          CON      750          ' No rotation

' -----[ Variables ]-----
temp            VAR      Word          ' Temporary variable
counter         VAR      Byte          ' Loop counting variable.
maneuver        VAR      Nib           ' SumoBot travel maneuver

' -----[ Main Routine ]-----
Test_Search_Pattern:
DO
  FOR counter = 1 TO 35                ' Forward 35 pulses
    maneuver = Forward
    GOSUB Pulse_Servos
  NEXT

  FOR counter = 1 TO 12                ' Rotate left 12 pulses
    maneuver = RotateLeft
    GOSUB Pulse_Servos
  NEXT

  FOR counter = 1 TO 24                ' Rotate right 24 pulses
    maneuver = RotateRight
    GOSUB Pulse_Servos
  NEXT

  FOR counter = 1 TO 12                ' Rotate Left 12 pulses
    maneuver = RotateLeft
    GOSUB Pulse_Servos
  NEXT

LOOP

' -----[ Subroutine - Pulse_Servos ]-----
Pulse_Servos:
' Pulse to left servo
LOOKUP maneuver, [FS_CCW, FS_CW, FS_CW, FS_CCW], temp
PULSOUT ServoLeft, temp

' Pulse to right servo
LOOKUP maneuver, [FS_CW, FS_CCW, FS_CW, FS_CCW], temp
PULSOUT ServoRight, temp

' Pause between pulses (remove when using IR object detectors + QTIs).
PAUSE 20
RETURN

```

Your Turn

Here is a wider variety of maneuver constants along with extra servo pulse width rotation constants you will need to implement all 10 maneuvers.

```
' ----- [ Constants ]-----
' SumoBot maneuver constants

Forward      CON    0          ' Forward
Backward     CON    1          ' Backward
RotateLeft   CON    2          ' Rotate in place turning left
RotateRight  CON    3          ' Rotate in place turning right
PivotLeft    CON    4          ' Pivot on 1 wheel turning left
PivotRight   CON    5          ' Pivot on 1 wheel turning right
CurveLeft    CON    6          ' Curve to the left
CurveRight   CON    7          ' Curve to the right
PivotLeftBack CON    8          ' Pivot backward-left
pivotRightBack CON    9          ' Pivot backward-right

' Servo pulse width rotation constants

FS_CCW       CON    850        ' Full speed counterclockwise
FS_CW        CON    650        ' Full speed clockwise
NO_ROT       CON    750        ' No rotation
LS_CCW       CON    770        ' Low speed counterclockwise
LS_CW        CON    730        ' Low speed clockwise
```

- √ Save ServoControlWithLookup.bs2 as ServoControlWithLookupYourTurn.bs2.
- √ Update the constants section with all the new declarations.

Here is the **Pulse_Servos** subroutine with its **LOOKUP** commands modified to accommodate the **PivotLeft** and **PivotRight** maneuvers:

```
Pulse_Servos:

' Pulse to left servo
LOOKUP maneuver, [ FS_CCW, FS_CW, FS_CW, FS_CCW,
                  NO_ROT, FS_CCW ], temp
PULSOUT ServoLeft, temp

' Pulse to right servo
LOOKUP maneuver, [ FS_CW, FS_CCW, FS_CW, FS_CCW,
                  FS_CW, NO_ROT ], temp
PULSOUT ServoRight, temp

' Pause between pulses (remove when using IR object detectors + QTIs)
PAUSE 20
RETURN
```

- ✓ Modify the `Pulse_Servos` subroutine to accommodate the rest of the maneuvers in the SumoBot maneuver constants list.
- ✓ For the `CurveLeft` and `CurveRight` maneuvers, tune them so that the SumoBot can do a full circle in the ring without passing over the white tawara line (see Figure 4-4).

4

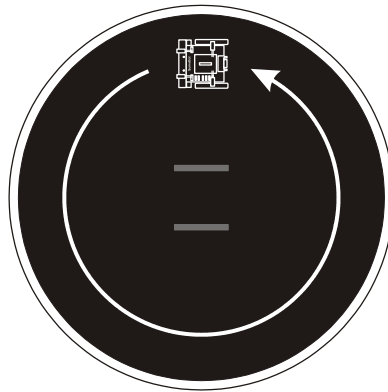

Figure 4-4
Circling inside the
Sumo Ring



Spend some time refining `CurveLeft` and `CurveRight`. These two maneuvers are strategically important to your SumoBot.

Since `maneuver` is a nibble variable, it can store any one of up to 16 different maneuvers. `LOOKUP` commands can have up to 256 different `value` arguments, so if you change the `maneuver` variable to a byte, you will likely have more maneuver possibilities than a person could dream up.

- ✓ Try making up some of your own, and add them to the maneuver constants list. Remember, you will need new entries added to the `LOOKUP` command's table.

ACTIVITY #2: SETTING YOUR SIGHTS ON THE OPPONENT

As soon as your SumoBot sees its opponent with one infrared object detecting "eye", it needs to maneuver so that it can see it with both eyes. There are lots of ways to do this. For example, the SumoBot can be programmed to do a standard Boe-Bot maneuver by rotating in place until it sees its opponent with both eyes. The drawback to this approach involves a nearby opponent shown in Figure 4-5. If your SumoBot halts all forward

motion and the opponent collides with it at that moment, it will be at a disadvantage. If the SumoBots are already pushing each other and one of them does this maneuver, it will also give its opponent an opportunity to push it closer to the white tawara line.

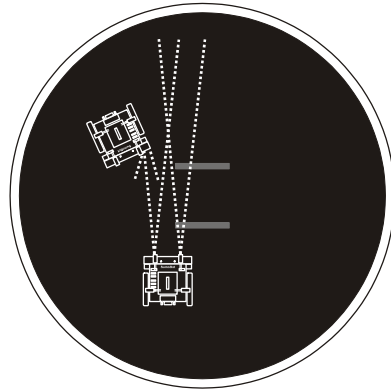

Figure 4-5
Nearby Opponent

*Seen by only one IR
object detector*

Other approaches include pivoting on one wheel and curving while continuing forward. Pivoting on one wheel has similar drawbacks to rotating in place. Drawing a curve has some advantages over an opponent that's very close. The curve keeps the SumoBot moving toward its opponent as it lines up to start pushing. If the two SumoBots are already pushing on each other, and the SumoBot happens to lose sight of its opponent with one eye for a moment, it doesn't lose as much advantage correcting with a curve. In some cases, it may even help.

Curving to see the opponent with both eyes has its own drawbacks though. For example, if the opponent is still some distance off and traveling away from the one eye that detected it, curving won't catch up with it. (See Figure 4-6.)

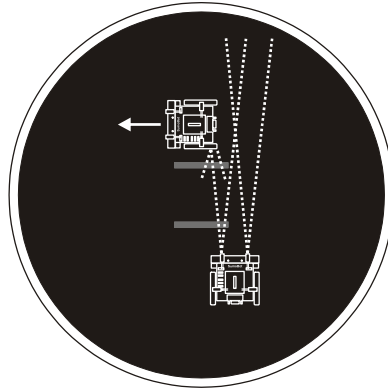

Figure 4-6
Nearby Opponent

Seen by one IR object detector, but not for long if curving is the only method employed.

4

You can also program the SumoBot for more complex maneuvers, such as curving for a while, then rotating in place. With a limited amount of curve time, it gives the SumoBot a chance to get lined up with its opponent if it is close to making contact or has already done so. If the opponent is across the ring and traveling away from the eye that detected it, following a limited curve by a rotate in place can really help.

This activity introduces some coding techniques for orchestrating single and multi-step maneuvers like the ones just described. Your SumoBot can use them to more effectively face its opponent. With some experimentation, you will likely settle on an optimal combination like curving and then rotating in place, or maybe curving, then pivoting. The final choice will be yours. The final choice of how long to curve, then how far to rotate in place will also be yours.

Executing a Maneuver While Watching the Sensors

This next example program makes the SumoBot pivot in place if it detects an object with only one eye. It pivots in place until it sees the object with both eyes, then lunges forward.



Remember, pivoting is probably not the best maneuver for this job. This example program uses it because it's both easy to explain, and easy to test. This activity's Your Turn section will introduce a more effective technique.

Regardless of whether it's pivoting, curving in place, or curving *then* rotating in place, *the key to making the maneuver successful is checking the sensors as often as possible.* One

way to ensure this is to keep a subroutine that's in charge of both sending pulses to the servos and checking sensors. In the code below, every time the Main Routine calls **Servos_And_Sensors**, both the **Pulse_Servos** subroutine and the sensors subroutines (**Read_Object_Detectors** in this case) get checked.

```
' -----[ Subroutine - Servos_And_Sensors ]-----
Servos_And_Sensors:
    GOSUB Pulse_Servos          ' Call Pulse_Servos subroutine
    ' Call sensor subroutine(s).
    sensors = 0                ' Clear previous sensor values
    GOSUB Read_Object_Detectors ' Call Read_Object_Detectors
    RETURN
```

Below is an excerpt from the next example program. The **ELSEIF** code block sets **maneuver** equal to **PivotLeft**, then it calls **Servos_And_Sensors**. The statement **DO UNTIL (irLF = 1 AND irRF = 1) OR counter > 15** is what looks for the correct condition. Notice that the loop has two conditions that will cause the program to exit the loop. The first is **(irLF = 1 AND irRF = 1)**. It makes the loop will automatically stop when the SumoBot has pivoted far enough to see the object with both eyes. The condition **...OR counter > 15** prevents the SumoBot from pivoting indefinitely while its opponent pushes it out of the ring.

```
DO
    IF irLF = 1 AND irRF = 1 THEN          ' Both?
        maneuver = Forward                ' State = Lunge forward
        GOSUB Servos_And_Sensors
    ELSEIF irLF = 1 THEN                  ' Just left?
        counter = 0                       ' State = track front left object
        DO UNTIL (irLF = 1 AND irRF = 1) OR counter > 15
            maneuver = PivotLeft          ' Pivot left 15
            GOSUB Servos_And_Sensors
            counter = counter + 1
        LOOP
    ELSEIF irRF = 1 THEN                  ' Just right?
        .
        .
        .
LOOP
```

You can test this next example program by positioning the SumoBot so that neither of its IR object detectors see an object. Then place your hand in front of one of the detectors. The SumoBot should rotate toward your hand until both detectors see it. Then it should lunge forward at your hand. If you remove your hand, the SumoBot will stop and wait. That's because the **ELSE** condition in the **IF...THEN...ELSIF...ELSE** statement. All it does is checks the IR detectors.

```
ELSE                                     ' No objects detected?
  GOSUB Read_Object_Detectors           ' State = search pattern
ENDIF
```

Example Program: FrontIrNavigation.bs2

- ✓ Enter, save, and run FrontIrNavigation.bs2.
- ✓ Place the SumoBot somewhere where any objects its detectors are pointing at will be more than a couple meters away. If there are objects near the ring, consider using an **IrFreq CON** directive with a value that makes the SumoBot nearsighted.
- ✓ Place your hand in front of the left IR object detector. The SumoBot should turn toward your hand, then lunge forward at it.
- ✓ Remove your hand, the SumoBot should stop moving.
- ✓ Repeat for the right object detector.
- ✓ Place your hand in front of both object detectors at the same time, then take it away again. So long as both **irLF** and **irRF** went from 0 to 1 at the same time, the SumoBot should lunge and stop immediately when you hand disappears from view.
- ✓ Wave your hand briefly in front of one of the detectors. The SumoBot should pivot for between 1/4 and 1/5 of a second before stopping.



Recycling sections and subroutines. This program was built by combining elements from other programs following the same procedure introduced in Chapter 2, Activity #6. Elements from the various declarations sections and subroutines were copied from two programs:

SensorsWithTempVariables.bs2 from Chapter 3, Activity #7, and
ServoControlWithLookup.bs2 from Activity #1 in this chapter.

Try incorporating TestResetButton.bs2 from Chapter 2, Activity #3. It'll make the program a lot easier to test.

```

' -----[ Title ]-----
' Applied Robotics with the SumoBot - FrontIrNavigation.bs2
' When it sees an object with only one object detecting eye, it corrects
' it's heading until it sees the object with both eyes.

' {$STAMP BS2}                               ' Target = BASIC Stamp 2
' {$PBASIC 2.5}                               ' Language = PBASIC 2.5

' -----[ I/O Definitions ]-----

ServoLeft      PIN    13                       ' Left servo connected to P13
ServoRight     PIN    12                       ' Right servo connected to P12

IrLedLS        PIN    2                       ' Left IR LED connected to P2
IrSenseLS      PIN    1                       ' Left IR detector to P1

IrLedLF        PIN    4                       ' Left IR LED connected to P4
IrSenseLF      PIN    11                      ' Left IR detector to P11

IrLedRF        PIN    15                      ' Right IR LED connected to P15
IrSenseRF      PIN    14                      ' Right IR detector to P14

IrLedRS        PIN    3                       ' Right IR LED connected to P3
IrSenseRS      PIN    0                       ' Right IR detector to P0

' -----[ Constants ]-----

' SumoBot maneuvers

Forward        CON    0                       ' Forward
Backward       CON    1                       ' Backward
RotateLeft     CON    2                       ' RotateLeft
RotateRight    CON    3                       ' RotateRight
PivotLeft      CON    4                       ' Pivot to the left
PivotRight     CON    5                       ' Pivot to the right
CurveLeft      CON    6                       ' Curve to the left
CurveRight     CON    7                       ' Curve to the right

' Servo pulse width rotations

FS_CCW         CON    850                     ' Full speed counterclockwise
FS_CW          CON    650                     ' Full speed clockwise
NO_ROT         CON    750                     ' No rotation
LS_CCW         CON    770                     ' Low speed counterclockwise
LS_CW          CON    730                     ' Low speed clockwise

' IR object detectors

IrFreq         CON    38500                   ' IR LED frequency

' -----[ Variables ]-----

```

```

temp          VAR      Word          ' Temporary variable
counter       VAR      Byte          ' Loop counting variable.

maneuver      VAR      Nib           ' SumoBot travel maneuver

sensors      VAR      Byte          ' Sensor flags byte

irLS         VAR      sensors.BIT3   ' State of Left Side IR
irLF         VAR      sensors.BIT2   ' State of Left Front IR
irRF         VAR      sensors.BIT1   ' State of Right Front IR
irRS         VAR      sensors.BIT0   ' State of Right Side IR

' -----[ Main Routine ]-----
DO
  IF irLF = 1 AND irRF = 1 THEN      ' Both?
    maneuver = Forward              ' State = Lunge forward
    GOSUB Servos_And_Sensors
  ELSEIF irLF = 1 THEN              ' Just left?
    counter = 0                     ' State = track front left object
    DO UNTIL (irLF = 1 AND irRF = 1) OR counter > 15
      maneuver = PivotLeft          ' Pivot left 15
      GOSUB Servos_And_Sensors
      counter = counter + 1
    LOOP
  ELSEIF irRF = 1 THEN              ' Just right?
    counter = 0                     ' State=track front right object
    DO UNTIL (irLF = 1 AND irRF = 1) OR counter > 15
      maneuver = PivotRight         ' Pivot right 15
      GOSUB Servos_And_Sensors
      counter = counter + 1
    LOOP
  ELSE                               ' No objects detected?
    GOSUB Read_Object_Detectors     ' State = search pattern
  ENDIF
LOOP

' -----[ Subroutine - Servos_And_Sensors ]-----
Servos_And_Sensors:
  GOSUB Pulse_Servos               ' Call Pulse_Servos subroutine
  ' Call sensor subroutine(s).

  sensors = 0                       ' Clear previous sensor values

  GOSUB Read_Object_Detectors       ' Call Read_Object_Detectors

```

```

RETURN
' -----[ Subroutine - Pulse_Servos ]-----
Pulse_Servos:
' Pulse to left servo
LOOKUP maneuver, [ FS_CCW, FS_CW, FS_CW, FS_CCW,
                  NO_ROT, FS_CCW, LS_CCW, FS_CCW ], temp
PULSOUT ServoLeft, temp

' Pulse to right servo
LOOKUP maneuver, [ FS_CW, FS_CCW, FS_CW, FS_CCW,
                  FS_CW, NO_ROT, FS_CW, LS_CW ], temp
PULSOUT ServoRight, temp

' Pause between pulses (remove when using IR object detectors + QTIs).
PAUSE 20

RETURN
' -----[ Subroutine - Read_Object_Detectors ]-----
Read_Object_Detectors:

FREQOUT IrLedRS, 1, IrFreq           ' Right side IR LED headlight
irRS = ~IrSenseRS                   ' Save right side IR receiver

FREQOUT IrLedRF, 1, IrFreq           ' Repeat for right-front
irRF = ~IrSenseRF

FREQOUT IrLedLF, 1, IrFreq           ' Repeat for left-front
irLF = ~IrSenseLF

FREQOUT IrLedLS, 1, IrFreq           ' Repeat for left side
irLS = ~IrSenseLS

RETURN

```

Your Turn - Orchestrating a Multi-Step Maneuver

Here is a two-step maneuver. The first **DO UNTIL...LOOP** curves toward the opponent. If it doesn't see the opponent with both eyes after 15 pulses, it moves on to the second step. In the second step, the SumoBot rotates in place (**maneuver = RotateLeft**) until either both IR detectors can see the opponent or until 30 pulses have completed. Again, that way, the SumoBot won't indefinitely rotate in place.

```

ELSEIF irLF = 1 THEN                                ' Just left?
DO UNTIL (irLF = 1 AND irRF = 1) OR counter > 15
  maneuver = CurveLeft                              ' Curve left 15
  GOSUB Servos_And_Sensors
  counter = counter + 1
LOOP
DO UNTIL (irLF = 1 AND irRF = 1) OR counter > 30
  maneuver = RotateLeft                             ' Rotate left 30
  GOSUB Servos_And_Sensors
  counter = counter + 1
LOOP

```

The Main Routine below incorporates this code for both sides, and is a drop-in replacement for the main routine in FrontIrNavigation.bs2.

- √ Save FrontIrNavigation.bs2 as FrontIrNavigationYourTurn.bs2.
- √ Replace the Main Routine in the program with the one shown below.
- √ Test the program and note the differences in the way the SumoBot faces and lunges toward your hand.

```

' -----[ Main Routine ]-----
DO
IF irLF = 1 AND irRF = 1 THEN                        ' Both?
  maneuver = Forward                                ' State = Lunge forward
  GOSUB Servos_And_Sensors
ELSEIF irLF = 1 THEN                                ' Just left?
  counter = 0                                       ' State = track front left object
DO UNTIL (irLF = 1 AND irRF = 1) OR counter > 15
  maneuver = CurveLeft                              ' Curve left 15
  GOSUB Servos_And_Sensors
  counter = counter + 1
LOOP
DO UNTIL (irLF = 1 AND irRF = 1) OR counter > 30
  maneuver = RotateLeft                             ' Rotate left 30
  GOSUB Servos_And_Sensors
  counter = counter + 1
LOOP
ELSEIF irRF = 1 THEN                                ' Just right?
  counter = 0                                       ' State=track front right object
DO UNTIL (irLF = 1 AND irRF = 1) OR counter > 15
  maneuver = CurveRight                             ' Curve right 15
  GOSUB Servos_And_Sensors
  counter = counter + 1
LOOP
DO UNTIL (irLF = 1 AND irRF = 1) OR counter > 30
  maneuver = RotateRight                             ' Rotate right 30

```

```

    GOSUB Servos_And_Sensors
    counter = counter + 1
  LOOP
ELSE                                     ' No objects detected?
  GOSUB Read_Object_Detectors           ' State = search pattern
ENDIF

LOOP

```

ACTIVITY #3: USING PERIPHERAL VISION

When autonomous robots start a sumo match facing each other, the match tends to be more a battle of brawn than brains. When a match starts with the SumoBot robots sideways to each other, things get a little more interesting. Is the opponent on the SumoBot's left or right, and for that matter, which direction is the opponent facing? Sumo cards like the ones shown in Figure 4-7 can help keep this random. Between each round in a match, a new card should be drawn to determine the placement of the SumoBots for the start of the next round.

Figure 4-7 Random Cards to Draw for Start Positions

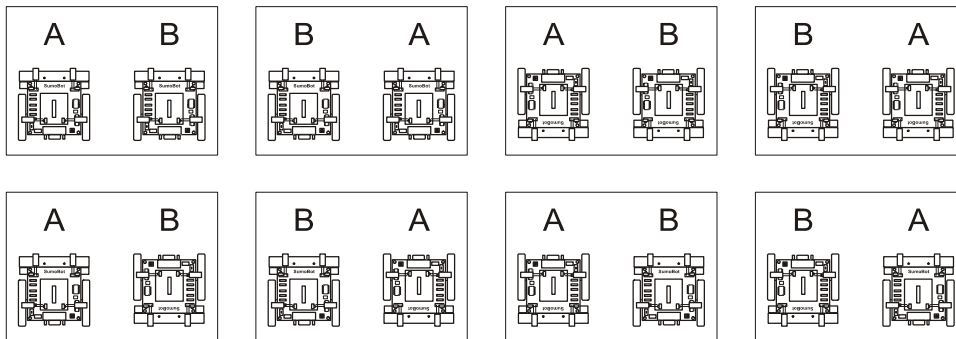

As shown in Figure 4-8, peripheral vision with the help of side mounted IR object detectors can give your SumoBot an advantage, both at the start of the match, and in detecting attacks from the side. This activity introduces a coding technique you can use to make effective use of the SumoBot's peripheral vision afforded by those side-mounted IR object detectors.

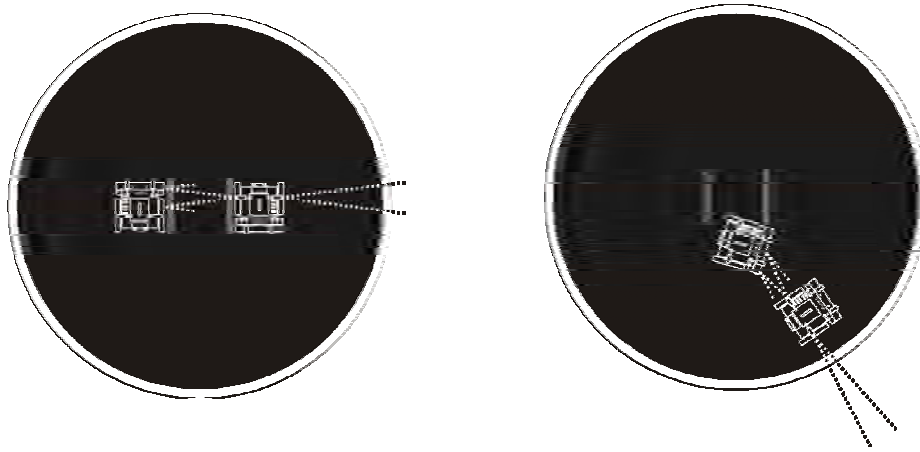
Figure 4-8 Peripheral Vision for Opponent Detection

4

Responding to an Object Detection on the Side

This code for side IR object detection works about the same as the examples from the previous activity. They can be added to the **IF...THEN** statements in the previous example program's main routine. They will make the SumoBot respond by rotating in place to turn toward objects it detects on either side. If an object is on the SumoBot's left side, the **ELSEIF irLS = 1 THEN** code block will get executed. The **DO UNTIL...LOOP** makes the SumoBot rotate left until either one of the front IR detectors sees the object. The **ELSEIF irRS = 1 THEN...** code block behaves similarly for objects on the right side.

```

ELSEIF irLS = 1 THEN                                ' Object left side?
  DO UNTIL irRF = 1 OR irLF = 1                      ' State = track left side object
    maneuver = RotateLeft                            ' Rotate left
    GOSUB Servos_And_Sensors
  LOOP
ELSEIF irRS = 1 THEN                                ' Object right side?
  DO UNTIL irRF = 1 OR irLF = 1                      ' State = track right side object
    maneuver = RotateRight                           ' Rotate right
    GOSUB Servos_And_Sensors
  LOOP

```

Example Program: FrontAndSideIrNavigation.bs2

The beauty in terminating the rotate loop as soon as one of the front IR detectors sees the object is that one of the other code blocks will then take over to get the SumoBot to face its opponent. Let's see how it performs:

- √ Save FrontIrNavigation.bs2 as FrontAndSideIrNavigation.bs2
- √ Insert the peripheral vision **ELSEIF...THEN...** code blocks shown above just before the **ELSE** keyword in the Main Routine.
- √ Use the printed example program to check your work.
- √ Run the program.
- √ Press and hold the Reset button as you take the SumoBot to the practice ring. Make sure there all objects are well away from the SumoBot's front and side. If there are objects near the ring, consider using an **IrFreq CON** directive that makes the SumoBot nearsighted.
- √ Set the SumoBot on the practice ring so that you are behind it. Otherwise, it will see you and react immediately. Make sure that there are no other objects within a couple meters of the ring.
- √ Let go of the Reset button. The SumoBot should stay still because it doesn't see anything.
- √ Place your hand in view of its right IR object detector. The SumoBot should immediately turn to face your hand and then lunge forward.
- √ Press and hold the Reset button, and again place the SumoBot so that it can't see you.
- √ Place your hand in view of its left IR object detector and verify that it rounds on an object to its left as well.

```
' -----[ Title ]-----
' Applied Robotics with the SumoBot - FrontAndSideIrNavigation.bs2
' This is FrontIrNavigation.bs2 with peripheral IR object detection added.

' {$STAMP BS2}                               ' Target = BASIC Stamp 2
' {$PBASIC 2.5}                               ' Language = PBASIC 2.5

' -----[ I/O Definitions ]-----

ServoLeft    PIN    13                        ' Left servo connected to P13
ServoRight   PIN    12                        ' Right servo connected to P12

IrLedLS     PIN    2                          ' Left IR LED connected to P2
IrSenseLS   PIN    1                          ' Left IR detector to P1
```

```

IrLedLF      PIN    4      ' Left IR LED connected to P4
IrSenseLF    PIN    11     ' Left IR detector to P11

IrLedRF      PIN    15     ' Right IR LED connected to P15
IrSenseRF    PIN    14     ' Right IR detector to P14

IrLedRS      PIN    3      ' Right IR LED connected to P3
IrSenseRS    PIN    0      ' Right IR detector to P0

' -----[ Constants ]-----
' SumoBot maneuvers

Forward      CON    0      ' Forward
Backward     CON    1      ' Backward
RotateLeft   CON    2      ' RotateLeft
RotateRight  CON    3      ' RotateRight
PivotLeft    CON    4      ' Pivot to the left
PivotRight   CON    5      ' Pivot to the right
CurveLeft    CON    6      ' Curve to the left
CurveRight   CON    7      ' Curve to the right

' Servo pulse width rotations

FS_CCW       CON    850    ' Full speed counterclockwise
FS_CW        CON    650    ' Full speed clockwise
NO_ROT       CON    750    ' No rotation
LS_CCW       CON    770    ' Low speed counterclockwise
LS_CW        CON    730    ' Low speed clockwise

' IR object detectors

IrFreq       CON    38500   ' IR LED frequency

' -----[ Variables ]-----

temp         VAR    Word    ' Temporary variable
counter      VAR    Byte    ' Loop counting variable.

maneuver     VAR    Nib     ' SumoBot travel maneuver

sensors      VAR    Byte    ' Sensor flags byte

irLS         VAR    sensors.BIT3 ' State of Left Side IR
irLF         VAR    sensors.BIT2 ' State of Left Front IR
irRF         VAR    sensors.BIT1 ' State of Right Front IR
irRS         VAR    sensors.BIT0 ' State of Right Side IR

' -----[ Main Routine ]-----
DO

```

```

IF irLF = 1 AND irRF = 1 THEN          ' Both?
  maneuver = Forward                 ' State = Lunge forward
  GOSUB Servos_And_Sensors
ELSEIF irLF = 1 THEN                  ' Just left?
  counter = 0                         ' State = track front left object
  DO UNTIL (irLF = 1 AND irRF = 1) OR counter > 15
    maneuver = CurveLeft              ' Curve left 15
    GOSUB Servos_And_Sensors
    counter = counter + 1
  LOOP
  DO UNTIL (irLF = 1 AND irRF = 1) OR counter > 30
    maneuver = RotateLeft             ' Rotate left 30
    GOSUB Servos_And_Sensors
    counter = counter + 1
  LOOP
ELSEIF irRF = 1 THEN                  ' Just right?
  counter = 0                         ' State=track front right object
  DO UNTIL (irLF = 1 AND irRF = 1) OR counter > 15
    maneuver = CurveRight            ' Curve right 15
    GOSUB Servos_And_Sensors
    counter = counter + 1
  LOOP
  DO UNTIL (irLF = 1 AND irRF = 1) OR counter > 30
    maneuver = RotateRight           ' Rotate right 30
    GOSUB Servos_And_Sensors
    counter = counter + 1
  LOOP
ELSEIF irLS = 1 THEN                  ' Object left side?
  DO UNTIL irRF = 1 OR irLF = 1      ' State = track left side object
    maneuver = RotateLeft            ' Rotate left
    GOSUB Servos_And_Sensors
  LOOP
ELSEIF irRS = 1 THEN                  ' Object right side?
  DO UNTIL irRF = 1 OR irLF = 1      ' State = track right side object
    maneuver = RotateRight           ' Rotate right
    GOSUB Servos_And_Sensors
  LOOP
ELSE                                   ' No objects detected?
  GOSUB Read_Object_Detectors        ' State = search pattern
ENDIF

LOOP

' -----[ Subroutine - Servos_And_Sensors ]-----
Servos_And_Sensors:
  GOSUB Pulse_Servos                 ' Call Pulse_Servos subroutine
  ' Call sensor subroutine(s).

```

```

sensors = 0                                ' Clear previous sensor values
GOSUB Read_Object_Detectors                 ' Call Read_Object_Detectors
RETURN

' -----[ Subroutine - Pulse_Servos ]-----
Pulse_Servos:
  ' Pulse to left servo
  LOOKUP maneuver, [ FS_CCW, FS_CW, FS_CW, FS_CCW,
                    NO_ROT, FS_CCW, LS_CCW, FS_CCW ], temp
  PULSOUT ServoLeft, temp

  ' Pulse to right servo
  LOOKUP maneuver, [ FS_CW, FS_CCW, FS_CW, FS_CCW,
                    FS_CW, NO_ROT, FS_CW, LS_CW ], temp
  PULSOUT ServoRight, temp

  ' Pause between pulses (remove when using IR object detectors + QTIs).
  PAUSE 20

  RETURN

' -----[ Subroutine - Read_Object_Detectors ]-----
Read_Object_Detectors:
  FREQOUT IrLedRS, 1, IrFreq                ' Right side IR LED headlight
  irRS = ~IrSenseRS                        ' Save right side IR receiver

  FREQOUT IrLedRF, 1, IrFreq                ' Repeat for right-front
  irRF = ~IrSenseRF

  FREQOUT IrLedLF, 1, IrFreq                ' Repeat for left-front
  irLF = ~IrSenseLF

  FREQOUT IrLedLS, 1, IrFreq                ' Repeat for left side
  irLS = ~IrSenseLS

  RETURN

```

Your Turn - Limiting Rotation

Unlike the front IR detectors, the loops for the side IR detectors do not limit the amount of rotation in place the SumoBot will perform.

- ✓ Add conditions to the **DO UNTIL...LOOP** code blocks that allow your SumoBot to turn and face objects detected to the side, but that prevent the SumoBot from rotating more than 180°.

Is it worth sweeping back in case the SumoBot might have missed something on its first rotation? Maybe. It might be something to fine tune after getting more familiar with how your SumoBot performs in matches.

ACTIVITY #4: INTRODUCTION TO STATE MACHINES AND DIAGRAMS

True to its name, a state machine is a machine that can operate in different states or modes of operation. A desk lamp is a very simple state machine, with two states, on or off. If the desk lamp starts out in the off state, and you flip its on/off switch, it will transition to the on state. Flip the switch again, and it transitions back to the off state. The act of flipping the switch is considered a condition that causes a transition from one state to another.

Traffic lights are somewhat more complex state machines, transitioning from green to yellow, to red, and then back to *green* again. In some traffic lights, these transitions are initiated by the traffic light's timer. Other traffic lights use a combination of a timer and sensors under the pavement. The transition from green to yellow might occur due to a timer, or it might occur because a car going the other direction is waiting (over the sensor under the pavement) for a green light. Both the timer and the sensor under the street provide the traffic light's state machine with conditions for changing states.



Reset state is another state machine term. For example, maintenance workers might shut off the power to the traffic lights at an intersection for repairs. When they turn the power back on, the traffic lights start in a particular pattern, such as red for the east/west street and green for the north/south street. Turning the power back on is an example of a reset condition, and green on north/south and red on east/west is would be called the initial or reset state.

Computers, cell phones, and factory production machines are significantly more complex state machines, but they still have something in common with desk lamps and traffic lights. They all operate in a finite number of states, and so they are defined as "finite

state machines". However, the term "state machine" is commonly used to refer to finite state machines.

Your SumoBot is without a doubt, a state machine. The last couple of example programs have used terms like "State = search pattern" and "State = track front left object" in the comments. The IR object detectors sense conditions, and the SumoBot's embedded BASIC Stamp executes a program that interprets each new condition and makes the transition to the correct state. Of course, the SumoBot reads the sensors and transitions between states because the PBASIC program it runs makes it do that.

This activity examines how PBASIC code can make the SumoBot transition from one state to the next based on sensor input. This activity also introduces a visual aid for planning the SumoBot's states and transitions - the state diagram.

A Simple State Diagram and Program

Figure 4-9 shows an example of a simple state diagram. Each circle signifies a state that the SumoBot can operate in. Both states are labeled, LED Off and Blink LED. Some of the arrows curve around and point back to the same state while other arrows point to the other state. These arrows represent state transitions. Each state transition arrow is labeled with a condition, like `pbSense = 0` or `pbSense = 1`. The reset condition is the arrow with the jagged shaft labeled Reset, and it indicates that this system will start in the LED Off state.

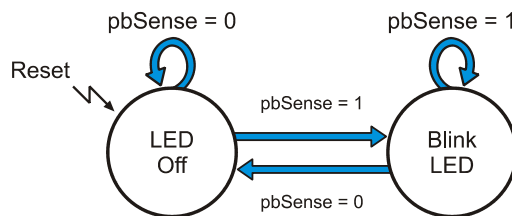

Figure 4-9
Simple State
Machine Diagram

The curved arrow that keeps returning to the LED off state labeled `pbSense = 0` indicates that so long as `pbSense` stores zero, the state machine will just keep transitioning back to the LED off state. The arrow that points from LED Off to Blink LED shows that when the condition is `pbSense = 1`, the state machine will transition from the LED off state to the Blink LED state. The Blink LED state also has two transition arrows, one that keeps it in

that state while `pbSense = 1`, and the other that transitions to LED off when `pbSense = 0`.

State diagrams can be visual aids for describing the different states in certain programs along with the conditions the programs use to transition from one state to the next. For example, `PushButtonLed.bs2` can be thought of as the instructions to make the SumoBot a state machine implementation of Figure 4-9.

Example Program: PushbuttonLed.bs2

- √ Enter, save, and run `PushButtonLed.bs2`
- √ Monitor the LED and Debug Terminal as you press and hold and then release the pushbutton on the SumoBot's breadboard. Do you agree that this program really does implement the state machine diagram in Figure 4-9? Is it the *only* way the figure can be implemented?

```
' Applied Robotics with the SumoBot - PushbuttonLed.bs2
' Simple finite state machine example.

' {$STAMP BS2}
' {$PBASIC 2.5}

pbSense    PIN 6
LedSpeaker PIN 5

LOW LedSpeaker

DO

  IF pbSense = 1 THEN
    DEBUG HOME, "State = Blink LED"
    TOGGLE LedSpeaker
  ELSE
    DEBUG HOME, "State = Led off", CLREOL
    LOW LedSpeaker
  ENDIF

  PAUSE 100

LOOP
```

Your Turn

Figure 4-10 shows a modified version of the state machine diagram that involves a variable named `counter`. Because of the 100 ms pause between repeats of the `DO...LOOP` in `PushbuttonLed.bs2`, the `counter` variable keeps the LED blink-time less than or equal to 2 seconds (assuming the `counter` starts at 1). It also ensures a 1 second delay before the LED starts blinking again, even if you keep pressing the button.

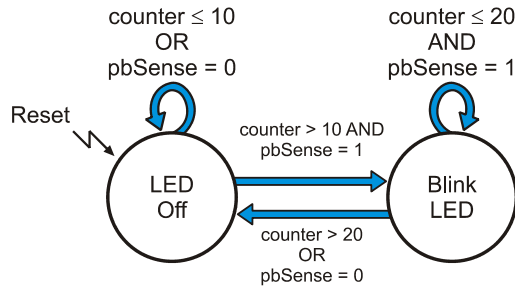

Figure 4-10
Modified State
Diagram

- ✓ Save `PushbuttonLed.bs2` as `PushbuttonLedYourTurn.bs2`.
- ✓ Modify the program so that it conforms to the state machine shown in Figure 4-10. Hint: use loops like `DO UNTIL counter ≥ 10` inside the `IF` and `ELSE` code blocks.
- ✓ Run and test the program, and trouble-shoot code as needed.

Hybrid State Diagrams for SumoBot Code Visual Aids

Here is the Main Routine from `FrontIrNavigation.bs2` (See Activity #2 in this chapter). If you rigidly adhered to the format from Figure 4-9 to make a state diagram for this code block, it would be pretty complicated. Certainly complicated enough to make it useless as a visual aid for designing more complex navigation routines.

DO

```

IF irLF = AND irRF = 1 THEN           ' Both?
  maneuver = Forward                 ' State = Lunge forward
  GOSUB Servos_And_Sensors
ELSEIF irLF = 1 THEN                 ' Just left?
  counter = 0                         ' State = track front left object
  DO UNTIL (irLF = AND irRF = 1) OR counter > 15
    maneuver = PivotLeft             ' Pivot left 15
    GOSUB Servos_And_Sensors
    counter = counter + 1
  
```

```

LOOP
ELSEIF irRF = 1 THEN                                ' Just right?
counter = 0                                          ' State=track front right object
DO UNTIL (irLF = AND irRF = 1) OR counter > 15
  maneuver = PivotRight                             ' Pivot right 15
  GOSUB Servos_And_Sensors
  counter = counter + 1
LOOP
ELSE                                                 ' No objects detected?
  GOSUB Read_Object_Detectors                       ' State = search pattern
ENDIF
LOOP

```

Software that is used for designing and modeling state machines that go into automated machinery and/or integrated circuits have various ways of both simplifying state diagrams and at the same time making them more versatile. One of the techniques is assigning priority to various conditions for transition from one state to another. That way, the programmer (or the software that writes the program from the hybrid state diagram) can decide in what order to examine each condition. It also simplifies the conditions and reduces the number of transitions. Another common technique is to have a node in the transition line that can branch to multiple states depending on multiple conditions – “conditional branch.”

Figure 4-11 shows an example of a hybrid state diagram that describes the FrontIrNavigation.bs2's Main Routine. The "Next State" state is unconventional, as are the numbers inside the Next State circle that show what order it evaluates the conditions for transition. Even so, the figure describes what's happening in the main routine much more succinctly than a normal state diagram.

Figure 4-11 Hybrid State Machine Diagram

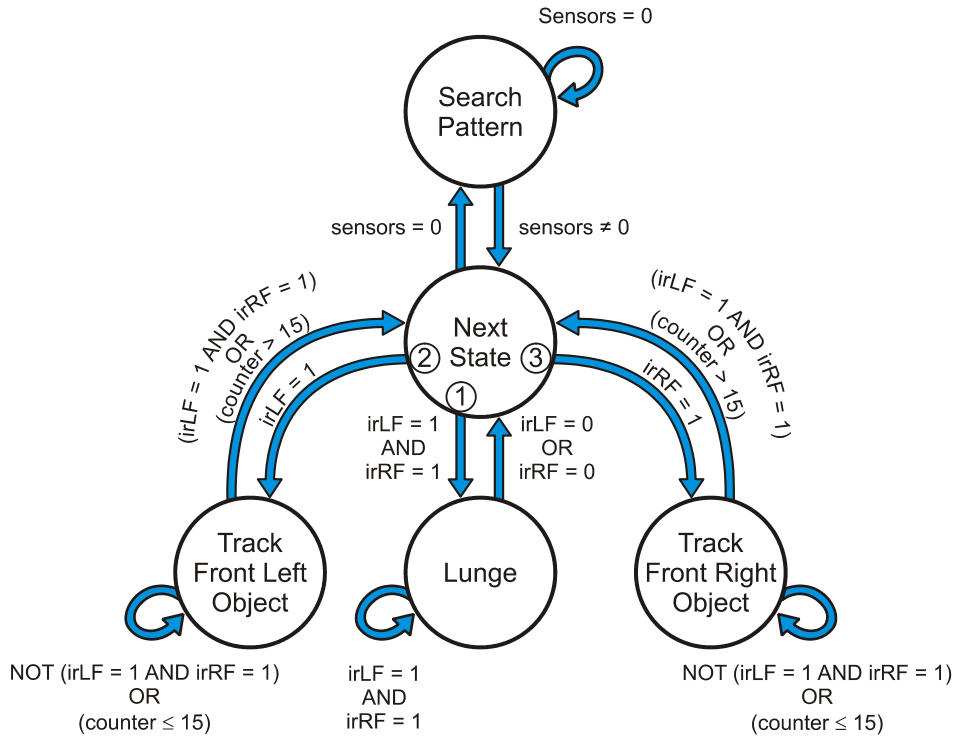

√ Compare Figure 4-11 to the Main Routine from FrontIrNavigation.bs2 and verify that they describe the same state transitions.

i **State diagrams are not a replacement for flowcharts.** While state diagrams introduced in this activity provide an overview of states in a state machine design, flow charts provide a detailed visual description of what the code in a program does. Flowcharts are introduced in the Stamps in Class *Industrial Control* text, available for download from www.parallax.com.

The NOT(*irLF* = 1 AND *irRF* = 1) conditions are taken care of implicitly by DO UNTIL (*irLF* = AND *irRF* = 1).

Your Turn - Drawing a State Machine Diagram

- √ Try drawing a hybrid state machine diagram for the Main Routine in `FrontAndSideIrNavigation.bs2` from this chapter's Activity #3.

ACTIVITY #5: SEARCH PATTERN AND TAWARA AVOIDANCE

Before your SumoBot will be ready for a match, it's got to be able to stay inside that white tawara line. When it doesn't see anything with its IR object detectors, it's also got to have a search pattern that's more effective than sitting in one spot and waiting. Especially for matches that start the SumoBots facing away from each other, an effective search technique can make a huge difference in your SumoBot's likelihood of winning each round. While this activity demonstrates one of many search patterns you can use, it will be up to you to develop an optimal search pattern for your SumoBot.

Another State Machine Main Routine

The example program in this activity is the QTI version of the programs from this Chapter's Activity #2 and Activity #3. Those programs combined the IR detection pin definitions, constants, variables, and subroutines developed in Chapter 3 with the navigation routines from Activity #1 in this chapter. The example program in this activity combines the QTI line sensor program elements that were developed in chapter 3, again with the navigation program elements developed in this chapter.

You've seen all the `PIN` and `DATA` directives, constant and variable declarations and subroutines before. The only thing that's really new is the Main Routine below, and even that follows the techniques similar to the ones introduced in this chapter's Activity #2 and #3.

Notice that the code blocks that handle the QTI detections (`IF qtiLF...`, `ELSIF qtiRF...`) do not have any sensor conditions for exiting the loops. While it makes absolutely sure that the SumoBot doesn't accidentally exit the ring chasing after a spectator who's too close, it also prevents the SumoBot from decisively finishing off its opponent in some cases. More about this double-edged sword on the Your Turn section.

```

' -----[ Main Routine ]-----
DO
  IF qtiLF = 1 THEN
    FOR counter = 1 TO 15
      maneuver = Backward
      GOSUB Servos_And_Sensors
    NEXT
    FOR counter = 1 TO 15
      maneuver = RotateRight
      GOSUB Servos_And_Sensors
    NEXT
  ELSEIF qtiRF = 1 THEN
    FOR counter = 1 TO 15
      maneuver = Backward
      GOSUB Servos_And_Sensors
    NEXT
    FOR counter = 1 TO 15
      maneuver = RotateLeft
      GOSUB Servos_And_Sensors
    NEXT
  .
  .
  .

```

The **ELSE** condition in the Main Routine performs the same search pattern introduced in this chapter's Activity #1, but with a twist - **IF sensors <> 0 THEN GOTO Next_State**. This **IF...THEN** statement is in all four **FOR...NEXT** loops in the search pattern. If none of the sensors see anything, each **FOR...NEXT** loop continues to execute. However, if any sensor sees something, the **sensors** variable will no longer be zero. When that happens, the **ELSE** condition terminates. Next, the outermost **DO...LOOP** in the Main Routine repeats itself, and the correct state for handling the sensor(s) that changed from 0 to 1 handle the situation. Since there are no IR detectors in this program, the only sensors that can cause this condition are the QTIs. In the next activity, all four IR detectors and both QTIs will have an opportunity to set a bit in the **sensors** variable, causing the program to terminate the search condition and transition to the state that handles the sensor that went high.

```

.
.
.
ELSE
  FOR counter = 1 TO 35
    maneuver = Forward
    GOSUB Servos_And_Sensors
    IF sensors <> 0 THEN GOTO Next_State
  NEXT

```

```

FOR counter = 1 TO 12                                ' Look right
  maneuver = RotateRight
  GOSUB Servos_And_Sensors
  IF sensors <> 0 THEN GOTO Next_State
NEXT
FOR counter = 1 TO 24                                ' Look left
  maneuver = RotateLeft
  GOSUB Servos_And_Sensors
  IF sensors <> 0 THEN GOTO Next_State
NEXT
FOR counter = 1 TO 12                                ' Re-align to forward
  maneuver = RotateRight
  GOSUB Servos_And_Sensors
  IF sensors <> 0 THEN GOTO Next_State
NEXT
Next_State:                                          ' Exit point of search pattern
ENDIF

LOOP

```

Figure 4-12 shows the search pattern. Because your servos may behave differently, it will probably take some tuning to get your SumoBot to perform this search pattern. While this search pattern works reasonably well, there's lots of room for improvement. We'll take a closer look in the Your Turn section.

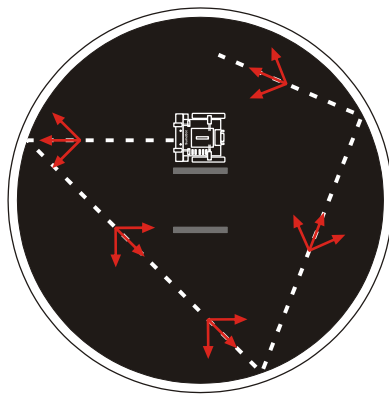

Figure 4-12
Sample SumoBot
Search Pattern

Example Program: SearchPatternAndAvoidTawara.bs2

- ✓ If you are using the SumoBot Robot Competition Ring Poster, make sure that you have followed the poster setup instructions (starting on page 9).
- ✓ Enter, save, and run SearchPatternAndAvoidTawara.bs2.

- ✓ Press and hold the Reset button until you place it on the ring as shown in Figure 4-12.
- ✓ Let go of the Reset button, and compare your search pattern to the one shown in the figure.

4

Does your SumoBot mistake creases in the poster for white tawara lines? If your SumoBot *backs up* and then executes a turn before it gets to the white tawara line, it may be detecting one or more of the creases in the SumoBot Competition Ring poster. This is most likely to happen when the SumoBot Competition Ring poster is in or near direct sunlight.

- ✓ If your SumoBot is having problems detecting the creases on the poster, go back to page 9 and make sure you have followed the setup instructions.

 If the lighting conditions are still too bright, you can make the QTI self calibration code set a lower threshold by changing this command:

```
multi = multi / 4           ' Take 1/4 average
```

- ✓ Instead of dividing `multi` by 4, try 5, 6, 7, 8, 9, and 10.

The higher the value divided into `multi`, the lower the threshold, and the less sensitive the SumoBot will be to creases in the poster. This is a bit of a double-edged sword, because it also makes the SumoBot less sensitive to the white tawara line, and we don't want it to miss that.

- ✓ Tune your **FOR...NEXT** loops so that your SumoBot's search pattern either starts to resemble the one in the figure, or if you have a search pattern in mind that you think will be effective, modify the State = search routine as you see fit.

```
' -----[ Title ]-----
' Applied Robotics with the SumoBot - SearchPatternAndAvoidTawara.bs2
' SumoBot searches the sumo ring for opponent and changes direction whenever
' it encounters the white Tawara line.

' {$STAMP BS2}           ' Target = BASIC Stamp 2
' {$PBASIC 2.5}         ' Language = PBASIC 2.5

' -----[ I/O Definitions ]-----

ServoLeft    PIN    13           ' Left servo connected to P13
ServoRight   PIN    12           ' Right servo connected to P12

qtiPwrLeft   PIN    10           ' Left QTI on/off pin P10
qtiSigLeft   PIN     9           ' Left QTI signal pin P9

qtiPwrRight  PIN     7           ' Right QTI on/off pin P7
qtiSigRight  PIN     8           ' Right QTI signal pin P8
```

```

DummyPin      PIN      6              ' I/O pin for pulse-decay P6
' ----- [ Constants ] -----
' SumoBot maneuvers
Forward       CON      0              ' Forward
Backward     CON      1              ' Backward
RotateLeft   CON      2              ' RotateLeft
RotateRight  CON      3              ' RotateRight
PivotLeft    CON      4              ' Pivot to the left
PivotRight   CON      5              ' Pivot to the right
CurveLeft    CON      6              ' Curve to the left
CurveRight   CON      7              ' Curve to the right

' Servo pulse width rotations
FS_CCW       CON      850           ' Full speed counterclockwise
FS_CW        CON      650           ' Full speed clockwise
NO_ROT       CON      750           ' No rotation
LS_CCW       CON      770           ' Low speed counterclockwise
LS_CW        CON      730           ' Low speed clockwise

' ----- [ Variables ] -----
temp         VAR      Word          ' Temporary variable
multi        VAR      Word          ' Multipurpose variable
counter      VAR      Byte          ' Loop counting variable.

maneuver     VAR      Nib           ' SumoBot travel maneuver
sensors     VAR      Byte          ' Sensor flags byte

qtiLF       VAR      sensors.BIT5   ' Stores snapshot of QtiSigLeft
qtiRF       VAR      sensors.BIT4   ' Stores snapshot of QtiSigRight

' ----- [ EEPROM Data ] -----
QtiThresh   DATA    Word 0         ' Word for QTI threshold time

' ----- [ Initialization ] -----
GOSUB Calibrate_Qtis              ' Determine b/w threshold

' ----- [ Main Routine ] -----
DO
  IF qtiLF = 1 THEN                ' Left qti sees line?
    FOR counter = 1 TO 15          ' State = Avoid tawara left

```



```

    maneuver = Backward          ' Back up
    GOSUB Servos_And_Sensors
NEXT
FOR counter = 1 TO 15          ' Turn right
    maneuver = RotateRight
    GOSUB Servos_And_Sensors
NEXT
ELSEIF qtiRF = 1 THEN         ' Right qti sees line?
    FOR counter = 1 TO 15     ' State = Avoid tawara right
        maneuver = Backward  ' Back up
        GOSUB Servos_And_Sensors
    NEXT
    FOR counter = 1 TO 15     ' Turn left
        maneuver = RotateLeft
        GOSUB Servos_And_Sensors
    NEXT
ELSE                           ' No objects detected?
    FOR counter = 1 TO 35     ' State = search pattern
        maneuver = Forward
        GOSUB Servos_And_Sensors
        IF sensors <> 0 THEN GOTO Next_State
    NEXT
    FOR counter = 1 TO 12     ' Look right
        maneuver = RotateRight
        GOSUB Servos_And_Sensors
        IF sensors <> 0 THEN GOTO Next_State
    NEXT
    FOR counter = 1 TO 24     ' Look left
        maneuver = RotateLeft
        GOSUB Servos_And_Sensors
        IF sensors <> 0 THEN GOTO Next_State
    NEXT
    FOR counter = 1 TO 12     ' Re-align to forward
        maneuver = RotateRight
        GOSUB Servos_And_Sensors
        IF sensors <> 0 THEN GOTO Next_State
    NEXT
    Next_State:              ' Exit point of search pattern
ENDIF

LOOP

' -----[ Subroutine - Calibrate_Qtis ]-----

Calibrate_Qtis:

HIGH qtiPwrLeft              ' Turn left QTI on
HIGH qtiSigLeft              ' Discharge capacitor
PAUSE 1

RCTIME qtiSigLeft, 1, temp    ' Measure charge time

```

```

LOW qtiPwrLeft          ' Turn left QTI off
multi = temp            ' Free temp for another RCTIME

HIGH qtiPwrRight        ' Turn right QTI on
HIGH qtiSigRight        ' Discharge capacitor
PAUSE 1
RCTIME qtiSigRight, 1, temp  ' Measure charge time

multi = (multi + temp) / 2  ' Calculate average

multi = multi / 4         ' Take 1/4 average

IF multi > 220 THEN      ' Account for code overhead
  multi = multi - 220
ELSE
  multi = 0
ENDIF

WRITE QtiThresh, Word multi  ' Threshold to EEPROM

RETURN

' -----[ Subroutine - Servos_And_Sensors ]-----
Servos_And_Sensors:

GOSUB Pulse_Servos        ' Call Pulse_Servos subroutine
' Call sensor subroutine(s).

sensors = 0               ' Clear previous sensor values

' GOSUB Read_Object_Detectors  ' Call Read_Object_Detectors
GOSUB Read_Line_Sensors  ' Look for lines

RETURN

' -----[ Subroutine - Pulse_Servos ]-----
Pulse_Servos:

' Pulse to left servo
LOOKUP maneuver, [ FS_CCW, FS_CW, FS_CW, FS_CCW,
                  NO_ROT, FS_CCW, LS_CCW, FS_CCW ], temp
PULSOUT ServoLeft, temp

' Pulse to right servo
LOOKUP maneuver, [ FS_CW, FS_CCW, FS_CW, FS_CCW,
                  FS_CW, NO_ROT, FS_CW, LS_CW ], temp
PULSOUT ServoRight, temp

```

```

' Pause between pulses (remove when using IR object detectors + QTIs).
PAUSE 20

RETURN

' -----[ Subroutine - Read_Line_Sensors ]-----
Read_Line_Sensors:

HIGH qtiPwrLeft           ' Turn on QTIs
HIGH qtiPwrRight
HIGH qtiSigLeft           ' Push signal voltages to 5 V
HIGH qtiSigRight
PAUSE 1                   ' Wait 1 ms for capacitors

READ QtiThresh, Word temp ' Get threshold time

INPUT qtiSigLeft          ' Start the decays
INPUT qtiSigRight

PULSOUT DummyPin, temp    ' Wait threshold time

qtiLF = ~qtiSigLeft       ' Snapshot of QTI signal states
qtiRF = ~qtiSigRight

LOW qtiPwrLeft            ' Turn off QTIS
LOW qtiPwrRight

RETURN

```

Your Turn - Looking Around at the Start and Designing a Search Pattern

Figure 4-13 is almost identical to Figure 4-12, but there is one important difference. In Figure 4-13, the SumoBot looks around before moving forward. Especially if your SumoBot doesn't happen to see its opponent at the beginning of the match, this first look-around could easily determine which competitor gets the Yuko point.

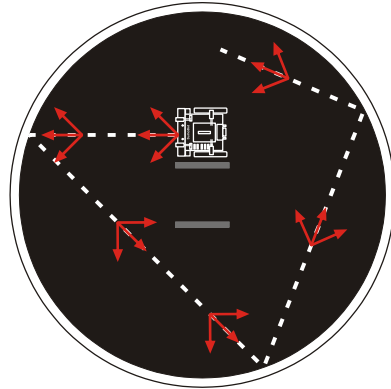

Figure 4-13
Sample SumoBot
Search Pattern

*This one is different
because the
SumoBot looks
around before it
starts going forward.*

There are a couple of different ways to get the SumoBot to do this maneuver. The first is to write a custom Initialization routine that performs this maneuver before moving on to the Main Routine. Here's another way.

- √ Save SearchPatternAndAvoidTawara.bs2 as a new file with YourTurn.bs2 appended to the name
- √ Add the `Look_About:` label to the search pattern code. It's commented with `' <--- Add Starting point` in the search pattern routine below.

```
ELSE                                     ' No objects detected?
  FOR counter = 1 TO 35                   ' State = search pattern
    maneuver = Forward
    GOSUB Servos_And_Sensors              ' Forward
    IF sensors <> 0 THEN GOTO Next_State
  NEXT
  Look_About:                             ' <--- Add Starting point label
  FOR counter = 1 TO 12                   ' Look right
    maneuver = RotateRight
    GOSUB Servos_And_Sensors
    IF sensors <> 0 THEN GOTO Next_State
  NEXT
  .
  .
  .
ENDIF
```

- √ Add the `GOTO Look_About` command to the end of the Initialization routine.

```
' -----[ Initialization ]-----
GOSUB Calibrate_Qtis      ' Determine b/w threshold
GOTO Look_About          ' <--- Add Start mid search pattern
```

- √ Run the modified program and verify that it makes the SumoBot look around before moving forward.

4

There are lots of questions to consider and test when designing a search pattern. For example, is it better to look around right after turning away from the tawara, or is it better to get away from it so that your SumoBot isn't at a disadvantage? You will have to answer these and other questions through experimentation.

One very important thing to keep in mind when designing a search pattern is how far your IR detectors can realistically see? While the infrared detectors might be good at seeing a white wall a meter or more away, a black SumoBot opponent isn't nearly as visible. One thing that will help is to measure the maximum reliable detection distance of the other SumoBot at the frequency you are using. Then, make a plot like the one shown in Figure 4-14. It will make it easier designing a path for your SumoBot to see as much as possible of the ring with the least travel time.

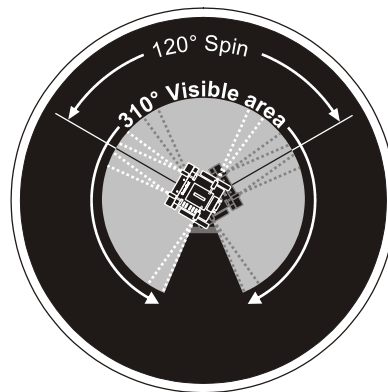

Figure 4-14
IR Detection Range
During Search
Pattern

- √ Design, program, and test your own SumoBot Search Pattern.

ACTIVITY #6: FULLY FUNCTIONAL SUMO EXAMPLE PROGRAMS

This activity features two fully functional SumoBot example programs. While they both do the same things; they are organized a little differently. The first is simply a combination of the example programs, mainly from this chapter. The second has the code for each state moved to subroutines.

First Sumo Program - Navigation Code in Main Routine

This first example program followed the same steps used in Chapter 2, Activity #6 for integrating programs. The three programs that were combined were:

- SearchPatternAndAvoidTawara.bs2 from Activity #6 in this chapter.
- FrontAndSideIrNavigation.bs2 from Activity #3 in this chapter.
- TestResetButton.bs2 from Chapter 2, Activity #2.

Example Program: TestSumoWrestler.bs2



Did you skip ahead to get here? If you skipped any thing in Chapter 3 or 4, go back and do it now.

The programs that follow are dependent upon the sensor circuits built, tested and calibrated in the previous activities in Chapter 3 and 4.

- √ Pick a sumo start card from Activity #3, Figure 4-7.
- √ Download TestSumoWrestler.bs2 to one SumoBot A and place it in the practice ring in position A.
- √ Save TestSumoWrestler.bs2 as MySumoWrestler.bs2.
- √ Incorporate your search pattern into the Main Routine.
- √ Download that program to SumoBot B.
- √ Place it in the practice ring in position B.
- √ Press/release both SumoBots' Reset buttons simultaneously.
- √ Fine tune the MySumoWrestler.bs2 program for victory.
- √ After enough tests to determine the probability of victory, make sure to repeat the test with the programs swapped. SumoBot A gets SumoBot B's program and vice versa.

```

' -----[ Title ]-----
' Applied Robotics with the SumoBot - TestSumoWrestler.bs2
' Fully functional state machine based sumo wrestling program
' with peripheral vision.

' {$STAMP BS2}           ' Target = BASIC Stamp 2
' {$PBASIC 2.5}         ' Language = PBASIC 2.5

' -----[ I/O Definitions ]-----

ServoLeft      PIN    13           ' Left servo connected to P13
ServoRight     PIN    12           ' Right servo connected to P12

qtiPwrLeft     PIN    10           ' Left QTI on/off pin P10
qtiSigLeft     PIN    9            ' Left QTI signal pin P9

qtiPwrRight    PIN    7            ' Right QTI on/off pin P7
qtiSigRight    PIN    8            ' Right QTI signal pin P8

DummyPin       PIN    6            ' I/O pin for pulse-decay P6

LedSpeaker     PIN    5            ' LED & speaker connected to P5

IrLedLS        PIN    2            ' Left IR LED connected to P2
IrSenseLS      PIN    1            ' Left IR detector to P1

IrLedLF        PIN    4            ' Left IR LED connected to P4
IrSenseLF      PIN    11           ' Left IR detector to P11

IrLedRF        PIN    15           ' Right IR LED connected to P15
IrSenseRF      PIN    14           ' Right IR detector to P14

IrLedRS        PIN    3            ' Right IR LED connected to P3
IrSenseRS      PIN    0            ' Right IR detector to P0

' -----[ Constants ]-----

' SumoBot maneuvers

Forward        CON    0            ' Forward
Backward       CON    1            ' Backward
RotateLeft     CON    2            ' RotateLeft
RotateRight    CON    3            ' RotateRight
PivotLeft      CON    4            ' Pivot to the left
PivotRight     CON    5            ' Pivot to the right
CurveLeft      CON    6            ' Curve to the left
CurveRight     CON    7            ' Curve to the right

' Servo pulse width rotations

FS_CCW        CON    850           ' Full speed counterclockwise

```

```

FS_CW          CON      650          ' Full speed clockwise
NO_ROT         CON      750          ' No rotation
LS_CCW         CON      770          ' Low speed counterclockwise
LS_CW          CON      730          ' Low speed clockwise

' IR object detectors

IrFreq         CON      38500        ' IR LED frequency

' -----[ Variables ]-----

temp           VAR      Word         ' Temporary variable
multi          VAR      Word         ' Multipurpose variable
counter        VAR      Byte         ' Loop counting variable.

maneuver       VAR      Nib          ' SumoBot travel maneuver

sensors        VAR      Byte         ' Sensor flags byte

qtiLF          VAR      sensors.BIT5 ' Stores snapshot of QtiSigLeft
qtiRF          VAR      sensors.BIT4 ' Stores snapshot of QtiSigRight

irLS           VAR      sensors.BIT3 ' State of Left Side IR
irLF           VAR      sensors.BIT2 ' State of Left Front IR
irRF           VAR      sensors.BIT1 ' State of Right Front IR
irRS           VAR      sensors.BIT0 ' State of Right Side IR

' -----[ EEPROM Data ]-----

RunStatus      DATA    0            ' Run status EEPROM byte
QtiThresh      DATA    Word 0       ' Word for QTI threshold time

' -----[ Initialization ]-----

GOSUB Reset                    ' Wait for Reset press/release
GOSUB Start_Delay              ' 5 Second delay
GOSUB Calibrate_Qtis           ' Determine b/w threshold
GOTO Look_About                ' Start mid search pattern

' -----[ Main Routine ]-----

DO

  IF qtiLF = 1 THEN            ' Left QTI sees line?
    FOR counter = 1 TO 15      ' State = Avoid tawara left
      maneuver = Backward      ' Back up
      GOSUB Servos_And_Sensors
    NEXT
    FOR counter = 1 TO 15      ' Turn right
      maneuver = RotateRight
      GOSUB Servos_And_Sensors
  
```



```

NEXT
ELSEIF qtiRF = 1 THEN           ' Right QTI sees line?
  FOR counter = 1 TO 15         ' State = Avoid tawara right
    maneuver = Backward        ' Back up
    GOSUB Servos_And_Sensors
  NEXT
  FOR counter = 1 TO 15         ' Turn left
    maneuver = RotateLeft
    GOSUB Servos_And_Sensors
  NEXT
ELSEIF irLF = 1 AND irRF = 1 THEN ' Both?
  maneuver = Forward           ' State = Lunge forward
  GOSUB Servos_And_Sensors
ELSEIF irLF = 1 THEN           ' Just left?
  counter = 0                  ' State = track front left object
  DO UNTIL (irLF = 1 AND irRF = 1) OR counter > 15
    maneuver = CurveLeft       ' Curve left 15
    GOSUB Servos_And_Sensors
    counter = counter + 1
  LOOP
  DO UNTIL (irLF = 1 AND irRF = 1) OR counter > 30
    maneuver = RotateLeft      ' Rotate left 30
    GOSUB Servos_And_Sensors
    counter = counter + 1
  LOOP
ELSEIF irRF = 1 THEN           ' Just right?
  counter = 0                  ' State=track front right object
  DO UNTIL (irLF = 1 AND irRF = 1) OR counter > 15
    maneuver = CurveRight      ' Curve right 15
    GOSUB Servos_And_Sensors
    counter = counter + 1
  LOOP
  DO UNTIL (irLF = 1 AND irRF = 1) OR counter > 30
    maneuver = RotateRight     ' Rotate right 30
    GOSUB Servos_And_Sensors
    counter = counter + 1
  LOOP
ELSEIF irLS = 1 THEN           ' Object left side?
  DO UNTIL irRF = 1 OR irLF = 1 ' State = track left side object
    maneuver = RotateLeft      ' Rotate left
    GOSUB Servos_And_Sensors
  LOOP
ELSEIF irRS = 1 THEN           ' Object right side?
  DO UNTIL irRF = 1 OR irLF = 1 ' State = track right side object
    maneuver = RotateRight     ' Rotate right
    GOSUB Servos_And_Sensors
  LOOP
ELSE                             ' No objects detected?
  FOR counter = 1 TO 35        ' State = search pattern
    maneuver = Forward
    GOSUB Servos_And_Sensors   ' Forward

```

```

    IF sensors <> 0 THEN GOTO Next_State
NEXT
Look_About:
FOR counter = 1 TO 12
    maneuver = RotateRight
    GOSUB Servos_And_Sensors
    IF sensors <> 0 THEN GOTO Next_State
NEXT
FOR counter = 1 TO 24
    maneuver = RotateLeft
    GOSUB Servos_And_Sensors
    IF sensors <> 0 THEN GOTO Next_State
NEXT
FOR counter = 1 TO 12
    maneuver = RotateRight
    GOSUB Servos_And_Sensors
    IF sensors <> 0 THEN GOTO Next_State
NEXT
Next_State:
ENDIF

LOOP

' -----[ Subroutine - Reset ]-----
Reset:

READ RunStatus, temp
temp = temp + 1
WRITE RunStatus, temp

IF (temp.BIT0 = 1) THEN
    DEBUG CLS, "Press/release Reset", CR,
    "button..."
    END
ELSE
    DEBUG CR, "Program running..."
ENDIF

RETURN

' -----[ Subroutine - Start_Delay ]-----
Start_Delay:

FOR counter = 1 TO 5
    PAUSE 900
    FREQOUT LedSpeaker, 100, 3000
NEXT

RETURN

```

```

' -----[ Subroutine - Calibrate_Qtis ]-----
Calibrate_Qtis:

HIGH qtiPwrLeft           ' Turn left QTI on
HIGH qtiSigLeft           ' Discharge capacitor
PAUSE 1

RCTYPE qtiSigLeft, 1, temp           ' Measure charge time

LOW qtiPwrLeft            ' Turn left QTI off
multi = temp                ' Free temp for another RCTYPE

HIGH qtiPwrRight          ' Turn right QTI on
HIGH qtiSigRight          ' Discharge capacitor
PAUSE 1
RCTYPE qtiSigRight, 1, temp           ' Measure charge time

multi = (multi + temp) / 2           ' Calculate average

multi = multi / 4            ' Take 1/4 average

IF multi > 220 THEN           ' Account for code overhead
  multi = multi - 220
ELSE
  multi = 0
ENDIF

WRITE QtiThresh, Word multi           ' Threshold to EEPROM

RETURN

' -----[ Subroutine - Servos_And_Sensors ]-----
Servos_And_Sensors:

GOSUB Pulse_Servos           ' Call Pulse_Servos subroutine
' Call sensor subroutine(s).

sensors = 0                   ' Clear previous sensor values

GOSUB Read_Object_Detectors   ' Call Read_Object_Detectors
GOSUB Read_Line_Sensors       ' Look for lines

RETURN

' -----[ Subroutine - Pulse_Servos ]-----
Pulse_Servos:

```

```

' Pulse to left servo
LOOKUP maneuver, [ FS_CCW, FS_CW, FS_CW, FS_CCW,
                  NO_ROT, FS_CCW, LS_CCW, FS_CCW ], temp
PULSOUT ServoLeft, temp

' Pulse to right servo
LOOKUP maneuver, [ FS_CW, FS_CCW, FS_CW, FS_CCW,
                  FS_CW, NO_ROT, FS_CW, LS_CW ], temp
PULSOUT ServoRight, temp

' Pause between pulses (remove when using IR object detectors + QTIs).
' PAUSE 20

RETURN

' -----[ Subroutine - Read_Object_Detectors ]-----
Read_Object_Detectors:

FREQOUT IrLedRS, 1, IrFreq           ' Right side IR LED headlight
irRS = ~IrSenseRS                   ' Save right side IR receiver

FREQOUT IrLedRF, 1, IrFreq           ' Repeat for right-front
irRF = ~IrSenseRF

FREQOUT IrLedLF, 1, IrFreq           ' Repeat for left-front
irLF = ~IrSenseLF

FREQOUT IrLedLS, 1, IrFreq           ' Repeat for left side
irLS = ~IrSenseLS

RETURN

' -----[ Subroutine - Read_Line_Sensors ]-----
Read_Line_Sensors:

HIGH qtiPwrLeft                      ' Turn on QTIs
HIGH qtiPwrRight
HIGH qtiSigLeft                       ' Push signal voltages to 5 V
HIGH qtiSigRight
PAUSE 1                               ' Wait 1 ms for capacitors

READ QtiThresh, Word temp             ' Get threshold time

INPUT qtiSigLeft                      ' Start the decays
INPUT qtiSigRight

PULSOUT DummyPin, temp               ' Wait threshold time

```

```

qtiLF = ~qtiSigLeft           ' Snapshot of QTI signal states
qtiRF = ~qtiSigRight

LOW qtiPwrLeft                 ' Turn off QTIS
LOW qtiPwrRight

RETURN

```

Moving the State Routines to Subroutines

Here is the Main Routine from the upcoming example program SumoWrestler.bs2, a revision of TestSumoWrestler.bs2 in which all of the state routines have been moved to subroutines. It's quite clean and easy to read, isn't it?

```

' -----[ Main Routine ]-----
DO

  IF qtiLF = 1 THEN           ' Left qti sees line?
    GOSUB Avoid_Tawara_Left   ' State = avoid left tawara
  ELSEIF qtiRF = 1 THEN      ' Right qti sees line?
    GOSUB Avoid_Tawara_Right  ' State = avoid right tawara
  ELSEIF irLF = 1 AND irRF = 1 THEN ' Both? Lunge forward
    GOSUB Go_Forward         ' State = Go forward
  ELSEIF irLF = 1 THEN       ' Just left?
    GOSUB Track_Front_Left_Object ' State = Track front left obj.
  ELSEIF irRF = 1 THEN       ' Just right?
    GOSUB Track_Front_Right_Object ' State = Track front right obj.
  ELSEIF irLS = 1 THEN       ' Left side?
    GOSUB Track_Side_Left_Object ' State = track side left obj.
  ELSEIF irRS = 1 THEN       ' Right side?
    GOSUB Track_Side_Right_Object ' State = track side right obj.
  ELSE                       ' Nothing sensed?
    GOSUB Search_Pattern      ' State = Search pattern
  ENDIF

LOOP

```

The code block for each navigation state now resides in a subroutine. Here is an example of `Avoid_Tawara_Left`. For the most part, the actual code in each subroutine is unchanged from the way it was in the main routine. The only difference is usually the label and `RETURN` command.

```

' -----[ Subroutine - Avoid_Tawara_Left ]-----
Avoid_Tawara_Left:

  FOR counter = 1 TO 15           ' Back up

```

```
maneuver = Backward
GOSUB Servos_And_Sensors
NEXT
FOR counter = 1 TO 15           ' Turn right
  maneuver = RotateRight
  GOSUB Servos_And_Sensors
NEXT
RETURN
```

There was one small problem that had to be corrected before the program would run properly. The last command in the initialization routine had to be changed from

```
GOTO Look_About           ' Start mid search pattern
```

to

```
GOSUB Look_About           ' Was Goto Look_About
```

The symptoms of this tiny coding mistake can be pretty discouraging. The SumoBot does its 5 second delay, then looks left, then looks right, then does nothing more... Here's why - the `Look_About` label is now in the `Search_Pattern` subroutine. `GOTO Look_About` sends the program to the `Look_About` label, and the program executes commands until it gets to `RETURN`. Since there was no `GOSUB` command before the `RETURN` command, the BASIC Stamp sends the program to its beginning. By connecting the SumoBot to the programming cable, the problem becomes clear, since the SumoBot does a couple of moves, and then displays "Press/Release Reset button..." That's an indication that the program is restarting, and the two most likely causes are tired batteries, or a `RETURN` command without a `GOSUB`.

Example Program: SumoWrestler.bs2



Did you skip ahead to get here? If you skipped any thing in Chapter 3 or 4, go back and do it now.

The programs that follow are dependent upon the sensor circuits built, tested and calibrated in the previous activities in Chapter 3 and 4.

- ✓ Examine SumoWrestler.bs2 and make sure the Main Routine and navigation state subroutines make sense to you.
- ✓ Make sure to substitute your `IrFreq` constant from Chapter 3, Activity #1 in place of the `IrFreq` constant in SumoWrestler.bs2. Use the one that most

- closely matches the conditions for your competition ring, taking into account nearby objects, whether or not the floor reflects infrared, etc.
- √ Also, make sure to adjust your QTI threshold calculation if you encountered problems with detecting the crease marks in the SumoBot Robot Competition Ring poster. See Activity #5 in this chapter.
 - √ Download your updated SumoWrestler.bs2 into SumoBot A.
 - √ Save a copy of the program as MySumoWithSubroutines.bs2.
 - √ Incorporate the changes you made in MySumoWrestler.bs2 into this new program's **Search_Pattern** subroutine. What differences did you encounter?
 - √ Download your updated MySumoWrestler.bs2 into SumoBot B.
 - √ Let them compete against each other using the same starting positions as the previous activity.

```
' -----[ Title ]-----
' Applied Robotics with the SumoBot - SumoWrestler.bs2
' SumoWrestler.bs2 modified so that each state is contained by a
' subroutine.

' {$STAMP BS2}                ' Target = BASIC Stamp 2
' {$PBASIC 2.5}              ' Language = PBASIC 2.5

' -----[ I/O Definitions ]-----

ServoLeft      PIN    13          ' Left servo connected to P13
ServoRight     PIN    12          ' Right servo connected to P12

qtiPwrLeft     PIN    10          ' Left QTI on/off pin P10
qtiSigLeft     PIN    9           ' Left QTI signal pin P9

qtiPwrRight    PIN    7           ' Right QTI on/off pin P7
qtiSigRight    PIN    8          ' Right QTI signal pin P8

DummyPin       PIN    6           ' I/O pin for pulse-decay P6

LedSpeaker     PIN    5           ' LED & speaker connected to P5

IrLedLS        PIN    2           ' Left IR LED connected to P2
IrSenseLS      PIN    1           ' Left IR detector to P1

IrLedLF        PIN    4           ' Left IR LED connected to P4
IrSenseLF      PIN    11          ' Left IR detector to P11

IrLedRF        PIN    15          ' Right IR LED connected to P15
IrSenseRF      PIN    14          ' Right IR detector to P14

IrLedRS        PIN    3           ' Right IR LED connected to P3
```

```

IrSenseRS      PIN      0          ' Right IR detector to P0

' -----[ Constants ]-----

' SumoBot maneuvers

Forward        CON      0          ' Forward
Backward       CON      1          ' Backward
RotateLeft     CON      2          ' RotateLeft
RotateRight    CON      3          ' RotateRight
PivotLeft      CON      4          ' Pivot to the left
PivotRight     CON      5          ' Pivot to the right
CurveLeft      CON      6          ' Curve to the left
CurveRight     CON      7          ' Curve to the right

' Servo pulse width rotations

FS_CCW        CON      850         ' Full speed counterclockwise
FS_CW         CON      650         ' Full speed clockwise
NO_ROT        CON      750         ' No rotation
LS_CCW        CON      770         ' Low speed counterclockwise
LS_CW         CON      730         ' Low speed clockwise

' IR object detectors

IrFreq        CON      38500        ' IR LED frequency

' -----[ Variables ]-----

temp          VAR      Word         ' Temporary variable
multi         VAR      Word         ' Multipurpose variable
counter       VAR      Byte         ' Loop counting variable.

maneuver      VAR      Nib          ' SumoBot travel maneuver

sensors       VAR      Byte         ' Sensor flags byte

qtiLF         VAR      sensors.BIT5  ' Stores snapshot of QtiSigLeft
qtiRF         VAR      sensors.BIT4  ' Stores snapshot of QtiSigRight

irLS         VAR      sensors.BIT3  ' State of Left Side IR
irLF         VAR      sensors.BIT2  ' State of Left Front IR
irRF         VAR      sensors.BIT1  ' State of Right Front IR
irRS         VAR      sensors.BIT0  ' State of Right Side IR

' -----[ EEPROM Data ]-----

RunStatus     DATA     0           ' Run status EEPROM byte
QtiThresh     DATA     Word 0      ' Word for QTI threshold time

' -----[ Initialization ]-----

```



```

GOSUB Reset                                ' Wait for Reset press/release
GOSUB Start_Delay                          ' 5 Second delay
GOSUB Calibrate_Qtis                       ' Determine b/w threshold
GOSUB Look_About                           ' Was Goto Look_About

' -----[ Main Routine ]-----
DO

  IF qtiLF = 1 THEN                         ' Left qti sees line?
    GOSUB Avoid_Tawara_Left                ' State = avoid left tawara
  ELSEIF qtiRF = 1 THEN                    ' Right qti sees line?
    GOSUB Avoid_Tawara_Right               ' State = avoid right tawara
  ELSEIF irLF = 1 AND irRF = 1 THEN        ' Both? Lunge forward
    GOSUB Go_Forward                       ' State = Go forward
  ELSEIF irLF = 1 THEN                     ' Just left?
    GOSUB Track_Front_Left_Object          ' State = Track front left obj.
  ELSEIF irRF = 1 THEN                     ' Just right?
    GOSUB Track_Front_Right_Object         ' State = Track front right obj.
  ELSEIF irLS = 1 THEN                     ' Left side?
    GOSUB Track_Side_Left_Object           ' State = track side left obj.
  ELSEIF irRS = 1 THEN                     ' Right side?
    GOSUB Track_Side_Right_Object          ' State = track side right obj.
  ELSE                                     ' Nothing sensed?
    GOSUB Search_Pattern                   ' State = Search pattern
  ENDIF

LOOP

' -----[ Subroutine - Reset ]-----
Reset:

  READ RunStatus, temp                     ' Byte @RunStatus -> temp
  temp = temp + 1                          ' Increment temp
  WRITE RunStatus, temp                    ' Store new value for next time

  IF (temp.BIT0 = 1) THEN                   ' Examine temp.BIT0
    DEBUG CLS, "Press/release Reset", CR,   ' 1 -> end, 0 -> keep going
      "button..."
    END
  ELSE
    DEBUG CR, "Program running..."
  ENDIF

  RETURN

' -----[ Subroutine - Start_Delay ]-----
Start_Delay:

```



```

READ QtiThresh, Word temp           ' Get threshold time

INPUT qtiSigLeft                     ' Start the decays
INPUT qtiSigRight

PULSOUT DummyPin, temp              ' Wait threshold time

qtiLF = ~qtiSigLeft                 ' Snapshot of QTI signal states
qtiRF = ~qtiSigRight

LOW qtiPwrLeft                      ' Turn off QTIS
LOW qtiPwrRight

RETURN

' -----[ Subroutine - Avoid_Tawara_Left ]-----
Avoid_Tawara_Left:

FOR counter = 1 TO 15                ' Back up
  maneuver = Backward
  GOSUB Servos_And_Sensors
NEXT
FOR counter = 1 TO 15                ' Turn right
  maneuver = RotateRight
  GOSUB Servos_And_Sensors
NEXT

RETURN

' -----[ Subroutine - Avoid_Tawara_Right ]-----
Avoid_Tawara_Right:

FOR counter = 1 TO 15                ' Back up
  maneuver = Backward
  GOSUB Servos_And_Sensors
NEXT
FOR counter = 1 TO 15                ' Turn left
  maneuver = RotateLeft
  GOSUB Servos_And_Sensors
NEXT

RETURN

' -----[ Subroutine - Go_Forward ]-----
Go_Forward:

maneuver = Forward                  ' 1 forward pulse
GOSUB Servos_And_Sensors

```

```

RETURN
' -----[ Subroutine - Track_Front_Left_Object ]-----
Track_Front_Left_Object:

counter = 0
DO UNTIL (irLF = 1 AND irRF = 1) OR counter > 15
  maneuver = CurveLeft          ' Curve left 15
  GOSUB Servos_And_Sensors
  counter = counter + 1
LOOP
DO UNTIL (irLF = 1 AND irRF = 1) OR counter > 30
  maneuver = RotateLeft        ' Rotate left 30
  GOSUB Servos_And_Sensors
  counter = counter + 1
LOOP

RETURN

' -----[ Subroutine - Track_Front_Right_Object ]-----
Track_Front_Right_Object:

counter = 0
DO UNTIL (irLF = 1 AND irRF = 1) OR counter > 15
  maneuver = CurveRight        ' Curve right 15
  GOSUB Servos_And_Sensors
  counter = counter + 1
LOOP
DO UNTIL (irLF = 1 AND irRF = 1) OR counter > 30
  maneuver = RotateRight      ' Rotate right 30
  GOSUB Servos_And_Sensors
  counter = counter + 1
LOOP

RETURN

' -----[ Subroutine - Track_Side_Left_Object ]-----
Track_Side_Left_Object:

DO UNTIL irRF = 1 OR irLF = 1          ' Rotate left
  maneuver = RotateLeft
  GOSUB Servos_And_Sensors
LOOP

RETURN

' -----[ Subroutine - Track_Side_Right_Object ]-----

```

```

Track_Side_Right_Object:

  DO UNTIL irRF = 1 OR irLF = 1           ' Rotate right
    maneuver = RotateRight
    GOSUB Servos_And_Sensors
  LOOP

  RETURN

' -----[ Subroutine - Search_Pattern ]-----
Search_Pattern:

  FOR counter = 1 TO 35                   ' and watch all sensors
    maneuver = Forward                   ' Forward
    GOSUB Servos_And_Sensors
    IF sensors <> 0 THEN GOTO Next_State
  NEXT
  Look_About:
  FOR counter = 1 TO 12                   ' Look right
    maneuver = RotateRight
    GOSUB Servos_And_Sensors
    IF sensors <> 0 THEN GOTO Next_State
  NEXT
  FOR counter = 1 TO 24                   ' Look left
    maneuver = RotateLeft
    GOSUB Servos_And_Sensors
    IF sensors <> 0 THEN GOTO Next_State
  NEXT
  FOR counter = 1 TO 12                   ' Re-align to forward
    maneuver = RotateRight
    GOSUB Servos_And_Sensors
    IF sensors <> 0 THEN GOTO Next_State
  NEXT

  Next_State:                             ' Exit point of search pattern

  RETURN

```

SUMMARY

This chapter introduced a technique that uses the `LOOKUP` command for adapting servo control to use with the `temp` and `counter` variables. It also introduced a subroutine that makes checking the sensors between each servo pulse automatic. `DO UNTIL...LOOP` code blocks were used to respond to a sensor with an action until another sensor event occurred or a counter exceeded a certain number of repetitions. This makes it possible for the SumoBot to react to sensor detections on either the front or side that causes it to face its opponent. Similar routines for detecting and avoiding the white tawara line were also introduced along with search patterns the SumoBot can use to locate its opponent more quickly and effectively.

The SumoBot navigation routines in this chapter can be conveniently viewed as state machines. Selected sensor detections cause the SumoBot to transition between different navigation states. State machine diagrams were introduced along with hybridized state machine diagrams as a potential visual aid for mapping the SumoBot's various responses to sensor events.

Two fully functional SumoWrestler programs were presented. Both make use of the majority of the techniques presented earlier in this book. One contains all the navigation states and state transitions in the main routine. The other only has state transitions in the Main Routine, and all the navigation states are handled in subroutines.

Questions

1. Which BASIC Stamp I/O pin does the X7 signal line connect to?
2. What feature of servo motion does a `FOR...NEXT` loop's `EndValue` control?
3. What feature of SumoBot motion does a `PULSOUT` command's `Pin` argument determine?
4. What do the numbers 700, 710, 720, 730 and 740 do for servo control?
5. Assuming a `FOR...NEXT` loop with 20 ms pauses, how many pulses will it take to make the servos go forward for 3 seconds?
6. What effect do sensors have on the amount of time a loop makes the servos run?
7. What combination of `PULSOUT` commands does it take to make the SumoBot execute a full speed reverse maneuver?
8. What combination of `PULSOUT` commands does it take to make the SumoBot execute a right turn (rotating in place)?

9. What combination of `PULSOUT` commands does it take to make the SumoBot execute a pivot-right turn?
10. In the lookup command review, what value will the `counter` variable have to store to make the `LOOKUP` command copy 1580 to the `note` variable?
11. What constant values were chosen for `Forward`, `Backward`, `RotateLeft`, and `RotateRight`?
12. What variable has to be set to a value before the `Pulse_Servos` subroutine is called?
13. What `PULSOUT` commands does `maneuver = 3; GOSUB Pulse_Servos` dictate?
14. What are the two kinds of conditions that are typically evaluated while executing a maneuver?
15. What programming elements are needed for the SumoBot to perform one maneuver if a sensor condition is detected and evaluate the results, then perform another maneuver if the results are undesirable?
16. How does responding to a peripheral vision detection differ from responding to a forward vision detection?
17. What is a reset condition?
18. What is a state?
19. In Figure 4-9, what condition keeps the LED off?
20. In Figure 4-9, what condition maintains the Blink LED state?
21. How do the `Avoid_Tawara` states differ from other states?
22. How can you make a program start in the beginning of its Main Routine loop?
23. In `TestSumoWrestler.bs2`, if the front right and front left QTIs detect the white tawara line at the same instant, what will happen?

Exercises

1. Write routines for `ServoControlExample.bs2` that make the SumoBot curve left and then curve right.
2. Write a routine that tests all the maneuvers you added to `ServoControlWithLookup.bs2` in the Your Turn section.
3. Write a routine for `FrontAndSideIrNavigation.bs2` that makes the SumoBot turn slowly in place until it finds an object to go after.
4. Draw a hybrid state machine diagram for the Main Routine in Activity #5.

Projects

1. Hold some sumo matches, and make sure to draw cards from the list in Figure 4-7 between each round.
2. Modify the two-eyed `Basic_Compensation_Program` from the *SumoBot Manual* text to improve its chances against the modified four-eyed SumoBot when starting from any of the positions in Figure 4-7.

Chapter #5: Debugging and Datalogging

If the SumoBot exhibits a problem behavior in the ring, figuring out the problem's actual cause can be rather confounding. Things happen pretty fast in the sumo ring, and it's often hard to discern what the SumoBot might have "seen" when you're watching a round. Especially if you extensively modify SumoWrestler.bs2 or add new sensors and navigation states, you might find yourself relying heavily on the techniques introduced in this chapter.

5



Author's Note

I relied heavily on the techniques in this chapter, especially Activity #3 and #4. They helped me figure out a number of problems, including program bugs, circuit continuity, and IR reflected off the floor outside the SumoBot competition ring.

SEEING WHAT IT SEES AND UNDERSTANDING WHAT IT DOES

Problem behaviors aren't always confounding. In fact, sometimes, it's pretty easy to guess the cause. In that case, simply using an LED to signal when the suspect part of the program starts to run will confirm your guess. Other times, you might expect the LED to come on, but it just doesn't.

At that point you might have to add pieces of code throughout your program that test other guesses. You may not want these pieces of test code to execute all the time, only when you tell them to. There's no need to waste variable space or set up a pushbutton controlled mode though, because the BASIC Stamp Editor supports compiler directives. These compiler directives are added to the program to make the BASIC Stamp Editor either include or leave out lines of code. It works both for multiple small statements scattered throughout the program as well as for really large blocks of diagnostic code.

One really nice thing about compiler directives is you can add the diagnostic code directly to the actual competition code. By simply changing one value at the beginning of your program, you can incorporate debugging routines that show every sensor detection, navigation state and maneuver your SumoBot chooses in slow motion. This makes it possible to see what it sees, and understand the decisions it makes. Most importantly, it's not in a separate test program, it's all part of the actual SumoWrestler.bs2 code.

Slow motion debugging leaves out one crucial element: the actual conditions the SumoBot experiences during a round. This is where datalogging comes in. The SumoBot can be programmed to save all the Debug Terminal information it displayed to EEPROM. After the round, you can play it all back, and match what the SumoBot saw and did to its problem behavior.

The Scientific Method

The five steps in the scientific method are:

1. State the problem
2. Make observations
3. Form a hypotheses
4. Do an experiment
5. Draw a conclusion

Following these steps may involve several iterations, with the first few conclusions being "the hypothesis does not explain the SumoBot's behavior." Even so, combined with the programming concepts introduced in this chapter, these five steps will serve you well.

ACTIVITY #1: USING THE LED TO SIGNAL AN EVENT

The LED can provide you with a number of quick tests to determine whether or not an event occurred. For example, let's say that the SumoBot has stopped responding to objects on its right side. The problem could be with the wiring, or it could be somewhere in your modified program.

Ruling out the wiring is easy. Just run `TestSideIrObjectDetectors.bs2` from Chapter 3, Activity #5. Then, simply waving your hand in front of the LED in question with the Debug Terminal running will tell you whether or not the circuit is working.

Assuming the wiring checks out okay, the LED can then be used to test and find out if the program is doing what it's supposed to. This activity demonstrates how you test for potential problems in the program by inserting LED code into key locations.

LED Bug Testing Examples

There are a lot of potential coding problems that can come up as you modify the program. For example, did the `irRF` bit get accidentally cleared somewhere in the program? If not, is there a problem with the looping code inside the `Track_Side_Right_Object` subroutine? Is there a problem with the program's branching?

Before testing each of these questions, it's important to make a disposable copy of the SumoWrestler.bs2.

- √ Save SumoWrestler.bs2 as CompCodeLedTest.bs2

Testing for a Cleared Bit

The first question was "...did the `irRF` bit get accidentally cleared somewhere in the program?" Some LED indicator code can certainly answer this question:

```
IF irRS = 1 THEN HIGH LedSpeaker ELSE LOW LedSpeaker
```

Where you put this line of code can make a big difference in your test. For example, if it's placed just after the sensor subroutines the program won't have a chance to do all the other things it does, which might include a coding mistake that clears the `irRF` bit. A better way to test this question would be to place the LED indicator code just before the sensor subroutines get called. That way, the program will go all the way through its other loops giving you better chances of exposing the bug.

- √ Modify the `Servos_And_Sensors` subroutine in `CompCodeLedTest.bs2` as shown here.

```
' -----[ Subroutine - Servos_And_Sensors ]-----
Servos_And_Sensors:
  GOSUB Pulse_Servos           ' Call Pulse_Servos subroutine
  ' Call sensor subroutine(s).
  IF irRS = 1 THEN HIGH LedSpeaker ELSE LOW LedSpeaker ' <--- Add
  sensors = 0                 ' Clear previous sensor values
  GOSUB Read_Object_Detectors  ' Call Read_Object_Detectors
  GOSUB Read_Line_Sensors     ' Look for lines
RETURN
```

- √ Run the modified program with the SumoBot's 3-position power switch set to 1.
- √ Make sure no objects are in view of the SumoBot's other three object detectors.
- √ Verify that it correctly indicates when the right side object detector sees and does not see an object. (Remember to press the SumoBot's Reset button and wait 5 seconds.

- √ Try it in the practice ring with the 3-position power switch set to 2.
- √ Start your test SumoBot with its opponent on the right and watch the LED to see if you can discern when it detects its opponent.
- √ After you are done with this test, make sure to either comment the **IF . . . THEN** statement by placing an apostrophe to the left of it, or just delete it. Otherwise, you will get incorrect results from the next test!



Did the SumoBot catch a glimpse of its opponent or not? Sometimes the LED might stay on too briefly to actually see. If you want to catch the event, simply remove the ELSE condition from the **IF . . . THEN** statement. It will cause the LED to turn on and stay on the first time the event you are testing occurs.

```
IF irRS = 1 THEN HIGH LedSpeaker
```

This statement is also really good for determining whether your IR object detectors are oversensitive and detecting far-off objects. Simply place the SumoBot in an empty ring and let it do its search pattern. If the LED comes on, the detector saw something it wasn't supposed to.

Testing the Subroutine's Looping Code

Next question: "... is there a problem with the looping code inside the **Track_Side_Right_Object** subroutine?" One effective way to test this is to put a **TOGGLE LedSpeaker** command inside the **DO...LOOP** in the **Track_Side_Right_Object** subroutine. It makes the LED flicker and the speaker click rapidly as the loop repeats. To keep from leaving the LED on after the subroutine is finished, it's a good idea to also add a **LOW LedSpeaker** command right before the **RETURN** command.

- √ Remember to first remove the test code from the **Servos_And_Sensors** subroutine.
- √ Modify the **Track_Side_Right_Object** subroutine in **CompCodeLedTest.bs2** as shown here.

```
' -----[ Subroutine - Track_Side_Right_Object ]-----
Track_Side_Right_Object:
DO UNTIL irRF = 1 OR irLF = 1           ' Rotate right
    TOGGLE LedSpeaker                 ' <--- Add
    maneuver = RotateRight
```

```

GOSUB Servos_And_Sensors

LOOP

LOW LedSpeaker          ' <--- Add

RETURN

```

- √ Run the modified program with the SumoBot's 3-position power switch set to 1.
- √ Make sure no objects are in view of the SumoBot's other three object detectors.
- √ Wave your hand in front of the right object detector.
- √ Verify that the LED blinks and the speaker clicks rapidly until you wave your hand in front of one of the front IR detectors.
- √ Try it in the practice ring with the 3-position power switch set to 2.
- √ Start your test SumoBot, again, with its opponent on the right.
- √ Press/release the Reset button, and verify that the LED flickers and the speaker clicks as it rounds on its opponent.
- √ Leave the LED code where it is for the next test.

5

If the LED doesn't flicker, there may be an object in front of the SumoBot, or there could be a branching problem. To test to find out if there is an object in front of the Boe-Bot, try moving the LED test to the `Go_Forward` subroutine. If the LED flickers constantly, then it confirms the problem. This test would also have to be repeated for the `Track_Front_Left_Object` and `Track_Front_Right_Object` subroutines.

Testing for Branching Problems

`IF...THEN`, `GOTO`, `GOSUB`, and `RETURN` are all examples of branching commands. They can cause the code to skip from one "branch" of the program to another. If a program has a branching problem, it would be because a command is telling the program to skip to a place you don't want it to go to.

Let's say this is the real bug in the program is in the Main Routine. In the code block below, the programmer typed `GOSUB Track_Side_Left_Object` twice by accident. It's the correct response to the first `ELSEIF`, but the second `ELSEIF` code block should call the `Track_Side_Right_Object` subroutine.

- √ Modify the main routine so that this bug is incorporated.

```

ELSEIF irLS = 1 THEN                ' Left side?
  GOSUB Track_Side_Left_Object      ' State = track side left obj.
ELSEIF irRS = 1 THEN                ' Right side?
  GOSUB Track_Side_Left_Object      ' State = track side right obj.

```

With this particular bug, the LED would not turn on in the previous test indicating that the code just wasn't making it there. Assuming you have already ruled out the possibility of the front IR object detectors seeing something, the next thing to examine is a branching problem.

- √ Start by repeating the **TOGGLE LedSpeaker** test in the **Track_Side_Right_Object** subroutine. The LED should not respond to waving your hand in front of the SumoBot's side-right object detector because the subroutine never gets called.
- √ Remove the **TOGGLE LedSpeaker** command and **LOW LedSpeaker** commands from the **Track_Side_Right_Object** subroutine.
- √ Add this **IF...THEN** statement to the **DO...LOOP** in the Main Routine.

```

DO
  IF irRS = 1 THEN HIGH LedSpeaker ELSE LOW LedSpeaker ' <--- Add
  IF qtiLF = 1 THEN                ' Left qti sees line?
    GOSUB Avoid_Tawara_Left        ' State = avoid left tawara

```

When you wave your hand in front of the right IR object detector, the LED should turn on. When you wave your hand in front of one of the front IR detectors, the LED should turn off again. That indicates that a navigation subroutine is getting called, it's just that it's not the right one. So now, check which one, and the problem will be found.

ACTIVITY #2: CONDITIONAL COMPILING

Commenting and uncommenting lines of test routines can be time consuming and leaves the door open for a lot of mistakes. Conditional compiler directives can help, and this activity demonstrates how.

Compiler Directives

Here is a new section, Compiler Definitions. These **#DEFINE** directives do not get downloaded to the BASIC Stamp. Instead, the BASIC Stamp Editor just makes a note to

itself that you have declared two symbols, `LED_MODE`, which has been set equal to one, and `DEBUG_MODE`, which has been set equal to two.

```
' -----[ Compiler Definitions ]-----
#DEFINE LED_MODE = 1
#DEFINE DEBUG_MODE = 2
```



Most compiler directives begin with #. Examples include `#DEFINE`, `#IF`, `#THEN`, `#ELSE`, `#SELECT`, and `#CASE`. The others begin with the dollar sign, such as `$STAMP` and `$PBASIC`.

5

The `#IF...#ENDIF` code block below is called a conditional compiler directive. The condition is `LED_MODE = 1`. If that's how `LED_MODE` was declared, then the `LedSpeaker PIN` directive will be compiled. In other words, the BASIC Stamp Editor will consider `LedSpeaker PIN 5` to be part of the program. If `LED_MODE` is any value other than 1, the `LedSpeaker PIN` directive would be ignored, just as comments are ignored.

```
' -----[ I/O Definitions ]-----
#IF LED_MODE = 1 #THEN
  LedSpeaker PIN 5
#ENDIF
```

Here is a variable declaration and `DEBUG` command that are not nested inside any conditional compiler directives, so they will be part of the program regardless of the value of `DEBUG_MODE` or `LED_MODE`.

```
' -----[ Variables ]-----
counter VAR Word

' -----[ Initialization ]-----
DEBUG CLS, "Program running...", CR, CR
```

Since `DEBUG_MODE` was declared as 2, only the command `DEBUG "DEBUG_MODE = 2."` will be part of the program. Again the commands in the other `#CASE` directives might as well be comments. However, if you change `#DEFINE DEBUG_MODE = 2` to `#DEFINE DEBUG_MODE = 0` and re-run the program, only the `DEBUG` command in the `#CASE 0` block will be compiled. The program would instead display the message `"DEBUG_MODE is zero."`

```
#SELECT DEBUG_MODE
#CASE 0
  DEBUG "DEBUG_MODE is zero."
#CASE 1
  DEBUG "DEBUG_MODE is one."
#CASE 2
  DEBUG "DEBUG_MODE is two."
#ENDSELECT
```

Because `LED_MODE` is 1, the code inside the commands nested in the `#IF LED_MODE = 1 #THEN` code block will become part of the program. The code inside the `#ELSE` block will be ignored, unless of course, you change the `#DEFINE LED_MODE` directive to zero.

```
' -----[ Main Routine ]-----
DO

  DEBUG CRSRX, 0, ? counter
  counter = counter + 1

  #IF LED_MODE = 1 #THEN

    DEBUG "LED state = ", BIN1 counter.BIT0, CRSRUP
    TOGGLE LedSpeaker
    PAUSE 200

  #ELSE

    DEBUG "LED_MODE disabled", CRSRUP
    PAUSE 100

  #ENDIF

LOOP
```

Example Program: CompilerDirectives.bs2

CompilerDirectives.bs2 can actually be six different programs. That's because it has conditional compiler directives for three different `DEBUG_MODES` and two different `LED_MODES`. This gives you six different combinations of `DEBUG_MODE` and `LED_MODE`.

- √ Based on the `LED_MODE` and `DEBUG_MODE #DEFINES`, predict what CompilerDirectives.bs2 is going to do when you download it to the BASIC Stamp.

- √ Enter, save, and run Compiler directives.bs2 and check the program's behavior against your predictions.
- √ Change #DEFINE LED_MODE = 1 to #DEFINE LED_MODE = 0.
- √ Predict how the program will behave the next time it is downloaded to the BASIC Stamp.
- √ Run the program, and again test your predictions.
- √ Repeat for the other four combinations of values that you can set LED_MODE and DEBUG_MODE equal to.

```
' -----[ Title ]-----
' Applied Robotics with the SumoBot - CompilerDirectives.bs2
' How to use compiler directives to select which code blocks to run.

' {$STAMP BS2}
' {$PBASIC 2.5}

' -----[ Compiler Definitions ]-----
#DEFINE LED_MODE = 1
#DEFINE DEBUG_MODE = 2

' -----[ I/O Definitions ]-----
#IF LED_MODE = 1 #THEN
  LedSpeaker PIN 5
#ENDIF

' -----[ Variables ]-----
counter VAR Word

' -----[ Initialization ]-----
DEBUG CLS, "Program running...", CR, CR

#SELECT DEBUG_MODE
  #CASE 0
    DEBUG "DEBUG_MODE is zero."
  #CASE 1
    DEBUG "DEBUG_MODE is one."
  #CASE 2
    DEBUG "DEBUG_MODE is two."
#ENDSELECT

DEBUG CR, CR

' -----[ Main Routine ]-----
```

```
DO
  DEBUG CRSRX, 0, ? counter
  counter = counter + 1

  #IF LED_MODE = 1 #THEN

    DEBUG "LED state = ", BIN1 counter.BIT0, CRSRUP
    TOGGLE LedSpeaker
    PAUSE 200

  #ELSE

    DEBUG "LED_MODE disabled", CRSRUP
    PAUSE 100

  #ENDIF
LOOP
```

Your Turn - Conditionally Compiling LED Commands

In Activity #1, you inserted four different PBASIC commands to make the LED notify you of certain events. One command was added to the Main Routine, another to the `Servos_And_Sensors` subroutine, and two commands were added to the `Track_Side_Right_Object` subroutine.

- √ Reopen the `CompCodeLedTest.bs2` from this chapter's activity #1
- √ Insert a `#DEFINE LED_MODE` declaration at the beginning of the program.
- √ Nest the LED test commands into `#IF...#THEN` blocks. Make sure that the test for each compiles its code based on a different value of `LED_MODE`, such as 1, 2, and 3. Then, if you declare `LED_MODE` to be 0, none of the LED test codes will be compiled.
- √ Test your program.

ACTIVITY #3: DEBUGGING PROBLEM BEHAVIORS

LED tests can provide a quick indication of what's happening in a certain place in a SumoBot's program, but that's about all it can do. In other words, the scope of LED tests tend to be somewhat limited.

This activity introduces a Debug Terminal diagnostic tool with a much broader scope. You can use it to watch all the sensors, navigation states and maneuvers the SumoBot

performs. This kind of tool can be really helpful for isolating both program and circuit bugs.

One important feature of this diagnostic tool, is that it all appears in conditional compiler directives. Because of this, you will be able to change one value in your program, and change it from a diagnostic tool back to competition code.

Incorporation Diagnostic Display Code in the SumoWrestler.bs2 Program

5

Watching the SumoBot's program play itself out in slow motion on the Debug Terminal makes it a lot easier to isolate problems with sensors, in the program, and so on. It also makes it easier to understand how the program reacts to various sensor conditions. This, in turn makes it easier to refine and improve the program, and also to add more sensors.

The example program for this activity started as SumoWrestler.bs2. After renaming the program, all the code that involves displaying the sensors, state, and maneuver values were added, nested in conditional compiler directives. This makes it possible to use one **#DEFINE** to change the program from a diagnostic tool to a competition program. The *Symbol* the program will use for these conditional compiler directives is **DEBUG_MODE**.

```
' -----[ Compiler Definitions ]-----
#DEFINE DEBUG_MODE = 1                    ' 1 -> full debug 0 -> wrestle
```

The **Display_All** subroutine required a few modifications to the program. First, some constants for the state values were added, again in a conditional compiler directive.

```
' -----[ Constants ]-----
.
.
.
#IF DEBUG_MODE = 1 #THEN
' State constants.
ATL          CON      0          ' Avoid_Tawara_Left
ATR          CON      1          ' Avoid_Tawara_Right
GF           CON      2          ' Go-Forward
TFLO        CON      3          ' Track_Front_Left_Object
TFRO        CON      4          ' Track_Front_Right_Object
TSLO        CON      5          ' Track_Side_Left_Object
TSRO        CON      6          ' Track_Side_Right_Object
SP           CON      7          ' Search_Pattern
#ENDIF
```

A variable named **state** is added to store these constants.

```
' ----- [ Variables ]-----
.
.
.
#IF DEBUG_MODE = 1 #THEN
state VAR Nib ' State machine value
#ENDIF
```

All the **sensor**, **state**, and **maneuver** values are displayed in a table, so a table heading is added to the Initialization section.

```
' ----- [ Initialization ]-----
.
.
.
#IF DEBUG_MODE = 1 #THEN
DEBUG CLS, ' Display table heading
" Sensors State Maneuver", CR,
"-----", CR
#ENDIF
```

Since all roads lead to the **Servos_And_Sensors** subroutine, that's the most logical place to put some code for displaying what's happening inside the program. In this example, the command **GOSUB Display_All** has been placed at the beginning of the subroutine. Remember, the subroutine call only becomes part of the program when **DEBUG_MODE = 1**.

```
' ----- [ Subroutine - Servos_And_Sensors ]-----
Servos_And_Sensors:
#IF DEBUG_MODE = 1 #THEN
GOSUB Display_All ' Call Display_All subroutine
#ENDIF
.
.
.
```

Since each subroutine represents a different operating 'state' for the SumoBot, code has to be added to the beginning of each one to set the value of the **state** variable. Here are some examples.

```
' ----- [ Subroutine - Avoid_Tawara_Left ]-----
Avoid_Tawara_Left:
#IF DEBUG_MODE = 1 #THEN state = ATL #ENDIF
.
```

```

.
.
' -----[ Subroutine - Avoid_Tawara_Right ]-----
Avoid_Tawara_Right:
    #IF DEBUG_MODE = 1 #THEN state = ATR #ENDIF
    .
    .
' -----[ Subroutine - Go_Forward ]-----
Go_Forward:
    #IF DEBUG_MODE = 1 #THEN state = GF #ENDIF
    .
    .

```

The **Display_All** subroutine displays the current **sensors** variable's value, navigation state, and maneuver. The **sensors** variable is displayed as an 8-bit binary value with the **BIN8** operator. All the states are displayed with abbreviations that match their constant names. The maneuver values are displayed as abbreviations of their constant names.

```

' -----[ Subroutine - Display_All ]-----
#IF DEBUG_MODE = 1 #THEN
Display_All:
    DEBUG BIN8 sensors,           ' Display sensors byte as bits
        CRSRX, 10                ' Cursor to column 10

    SELECT state                  ' Display state
    CASE ATL
        DEBUG "ATL"
    CASE ATR
        DEBUG "ATR"
    CASE GF
        DEBUG "GF"
    CASE TFLO
        DEBUG "TFLO"
    CASE TFRO
        DEBUG "TFRO"
    CASE TSLO
        DEBUG "TSLO"
    CASE TSRO
        DEBUG "TSRO"
    CASE SP
        DEBUG "SP"

```

```

ENDSELECT

DEBUG CRSRX, 20                                ' Cursor to column 20

SELECT maneuver                                ' Display maneuver
CASE Forward
  DEBUG "Fwd"
CASE Backward
  DEBUG "Bkwd"
CASE RotateLeft
  DEBUG "RotLft"
CASE RotateRight
  DEBUG "RotRt"
CASE CurveLeft
  DEBUG "CrvLft"
CASE CurveRight
  DEBUG "CrvRt"
ENDSELECT

DEBUG CR                                        ' Carriage return for next line

PAUSE 200                                      ' Pause 0.2 seconds for reading.

RETURN

#endif

```

Example Program: SumoWrestlerWithDebugMode.bs2

With this program, you can examine what the SumoBot sees and how its program responds. Before going into how it works, recall that Chapter 3, Activity #7 demonstrated how to read the bits in the `sensors` variable. Figure 5-1 shows the `sensors` variable storing an example value.

Sensors Variable

<u>0</u>	<u>0</u>	<u>0</u>	<u>0</u>	<u>0</u>	<u>1</u>	<u>1</u>	<u>0</u>
	q	q	i	i	i	i	
	t	t	r	r	r	r	
	i	i	L	L	R	R	
	L	R	S	F	F	S	
	F	F					

Figure 5-1
Sensors Variable

Six of the eight bits each correspond to a different SumoBot sensor. Two bits are unused.

In this case, there is an object directly in front of the SumoBot because both the left and right IR object detectors (`irLF` and `irRF`) store 1s. The IR object detectors on the left and

right sides (*irLS* and *irRS*) do not detect objects, because they store 0s. The same applies to the left and right front QTI object detectors (*qtiLF* and *qtiRF*), which both see the black sumo ring surface.

Figure 5-2 shows an example of what the Debug Terminal displays.

```

Debug Terminal #1
Com Port: COM6  Baud Rate: 9600  Parity: None  Data Bits: 8  Flow Control: Off
TX RX DTR RTS DSR CTS
-----
Sensors  State  Maneuver
-----
00000000 SP    RotRt
00001000 TSLO  RotLft
00001000 TSLO  RotLft
00001000 TSLO  RotLft
00001000 TSLO  RotLft
00001000 TSLO  RotLft
00001100 TFLO  CrvLft
00001100 TFLO  CrvLft
00001100 TFLO  CrvLft
00001100 TFLO  CrvLft
00000110 GF    Fwd
00000110 GF    Fwd
00000110 GF    Fwd
00000110 GF    Fwd
00000000 SP    Fwd
00000000 SP    Fwd
00100000 ATL  Bkwd
00100000 ATL  Bkwd
00100000 ATL  Bkwd
00100000 ATL  Bkwd
-----
Macros...  Resume  Clear  Close  Echo Off

```

5

Figure 5-2
Debug Terminal

DEBUG_MODE = 1.

In the first row, none of the sensors see anything, the state is search pattern (**SP**), and the SumoBot is starting by rotating right. On the second row, the SumoBot has detected an object on its left, and the state has transitioned to track side left object (**TSLO**). The maneuver is rotate left (**RotLft**). The object is then moved in front of the front-left IR object detector. The state transitions to track front left object (**TFLO**), and the maneuver is curve left (**CrvLft**). Then, the object is moved in front of both IR detectors, which transitions the SumoBot to the go forward state (**GF**) with the forward maneuver (**Fwd**). The object is then taken away, and the left QTI is placed over the white tawara line. This results in the avoid tawara left (**ATL**) state, which starts out with backing up (**Blkwd**).

- √ Leave the SumoBot connected to the serial cable as you set it on the competition ring.
- √ Set the 3-position power switch to position-1.
- √ Enter, save, and run SumoWrestlerWithDebugMode.bs2.
- √ Press/release the SumoBot's Reset button.
- √ To emulate the output shown in Figure 5-2, start with an object on the SumoBot's left side.
- √ Move it from the left side to the left front, then in front of both IR detectors. Then, take the object away, and place the left QTI over the white tawara line.
- √ Experiment with various sensor events, and compare events displayed in the Debug Terminal to what the program is supposed to do for each event.
- √ Set **DEBUG_MODE** to 0 and download the modified program to the SumoBot.
- √ Move the 3-position power switch to position-2.
- √ Press and release Reset, and verify that the program now functions at full speed, with no diagnostic code.

```
' -----[ Title ]-----
' Applied Robotics with the SumoBot - SumoWrestlerWithDebugMode.bs2
' SumoWrestlerWithStateSubroutines.bs2 modified so that
' you can toggle DEBUG_MODE between 0 (competition mode) and 1 (display mode).

' {$STAMP BS2}                               ' Target = BASIC Stamp 2
' {$PBASIC 2.5}                               ' Language = PBASIC 2.5

' -----[ Compiler Definitions ]-----
#define DEBUG_MODE = 1                        ' 1 -> full debug 0 -> wrestle

' -----[ I/O Definitions ]-----
```

```

ServoLeft      PIN    13      ' Left servo connected to P13
ServoRight     PIN    12      ' Right servo connected to P12

qtiPwrLeft     PIN    10      ' Left QTI on/off pin P10
qtiSigLeft     PIN    9       ' Left QTI signal pin P9

qtiPwrRight    PIN    7       ' Right QTI on/off pin P7
qtiSigRight    PIN    8       ' Right QTI signal pin P8

DummyPin       PIN    6       ' I/O pin for pulse-decay P6

LedSpeaker     PIN    5       ' LED & speaker connected to P5

IrLedLS        PIN    2       ' Left IR LED connected to P2
IrSenseLS      PIN    1       ' Left IR detector to P1

IrLedLF        PIN    4       ' Left IR LED connected to P4
IrSenseLF      PIN    11      ' Left IR detector to P11

IrLedRF        PIN    15      ' Right IR LED connected to P15
IrSenseRF      PIN    14      ' Right IR detector to P14

IrLedRS        PIN    3       ' Right IR LED connected to P3
IrSenseRS      PIN    0       ' Right IR detector to P0

' -----[ Constants ]-----

' SumoBot maneuvers

Forward        CON    0       ' Forward
Backward       CON    1       ' Backward
RotateLeft     CON    2       ' RotateLeft
RotateRight    CON    3       ' RotateRight
PivotLeft      CON    4       ' Pivot to the left
PivotRight     CON    5       ' Pivot to the right
CurveLeft      CON    6       ' Curve to the left
CurveRight     CON    7       ' Curve to the right

' Servo pulse width rotations

FS_CCW        CON    850     ' Full speed counterclockwise
FS_CW         CON    650     ' Full speed clockwise
NO_ROT        CON    750     ' No rotation
LS_CCW        CON    770     ' Low speed counterclockwise
LS_CW         CON    730     ' Low speed clockwise

' IR object detectors

IrFreq        CON    38500    ' IR LED frequency

#IF DEBUG_MODE = 1 #THEN

```

```

' State constants.
ATL          CON      0          ' Avoid_Tawara_Left
ATR          CON      1          ' Avoid_Tawara_Right
GF           CON      2          ' Go-Forward
TFLO        CON      3          ' Track_Front_Left_Object
TFRO        CON      4          ' Track_Front_Right_Object
TSLO        CON      5          ' Track_Side_Left_Object
TSRO        CON      6          ' Track_Side_Right_Object
SP           CON      7          ' Search_Pattern
#ENDIF

' -----[ Variables ]-----

temp         VAR      Word       ' Temporary variable
multi        VAR      Word       ' Multipurpose variable
counter      VAR      Byte       ' Loop counting variable.

maneuver     VAR      Nib        ' SumoBot travel maneuver

sensors      VAR      Byte       ' Sensor flags byte

qtiLF        VAR      sensors.BIT5 ' Stores snapshot of QtiSigLeft
qtiRF        VAR      sensors.BIT4 ' Stores snapshot of QtiSigRight

irLS         VAR      sensors.BIT3 ' State of Left Side IR
irLF         VAR      sensors.BIT2 ' State of Left Front IR
irRF         VAR      sensors.BIT1 ' State of Right Front IR
irRS         VAR      sensors.BIT0 ' State of Right Side IR

#IF DEBUG_MODE = 1 #THEN
state        VAR      Nib        ' State machine value
#ENDIF

' -----[ EEPROM Data ]-----

RunStatus    DATA    0          ' Run status EEPROM byte
QtiThresh    DATA    Word 0     ' Word for QTI threshold time

' -----[ Initialization ]-----

GOSUB Reset          ' Wait for Reset press/release
GOSUB Start_Delay    ' 5 Second delay
GOSUB Calibrate_Qtis ' Determine b/w threshold

#IF DEBUG_MODE = 1 #THEN
DEBUG CLS,          ' Display table heading
"Sensors  State  Maneuver", CR,
"-----  -----  -----", CR
#ENDIF

GOSUB Look_About    ' Was Goto Look_About

```

```

' -----[ Main Routine ]-----
DO

  IF qtiLF = 1 THEN                                ' Left qti sees line?
    GOSUB Avoid_Tawara_Left                        ' State = avoid left tawara
  ELSEIF qtiRF = 1 THEN                            ' Right qti sees line?
    GOSUB Avoid_Tawara_Right                      ' State = avoid right tawara
  ELSEIF irLF = 1 AND irRF = 1 THEN               ' Both? Lunge forward
    GOSUB Go_Forward                             ' State = Go forward
  ELSEIF irLF = 1 THEN                            ' Just left?
    GOSUB Track_Front_Left_Object                ' State = Track front left obj.
  ELSEIF irRF = 1 THEN                            ' Just right?
    GOSUB Track_Front_Right_Object               ' State = Track front right obj.
  ELSEIF irLS = 1 THEN                            ' Left side?
    GOSUB Track_Side_Left_Object                 ' State = track side left obj.
  ELSEIF irRS = 1 THEN                            ' Right side?
    GOSUB Track_Side_Right_Object               ' State = track side right obj.
  ELSE                                            ' Nothing sensed?
    GOSUB Search_Pattern                        ' State = Search pattern
  ENDIF

LOOP

' -----[ Subroutine - Reset ]-----
Reset:

  READ RunStatus, temp                            ' Byte @RunStatus -> temp
  temp = temp + 1                                ' Increment temp
  WRITE RunStatus, temp                          ' Store new value for next time

  IF (temp.BIT0 = 1) THEN                        ' Examine temp.BIT0
    DEBUG CLS, "Press/release Reset", CR,        ' 1 -> end, 0 -> keep going
      "button..."
  END
  ELSE
    DEBUG CR, "Program running..."
  ENDIF

  RETURN

' -----[ Subroutine - Start_Delay ]-----
Start_Delay:

  FOR counter = 1 TO 5                          ' 5 beeps, 1/second
    PAUSE 900
    FREQOUT LedSpeaker, 100, 3000
  NEXT

```

```

RETURN
' -----[ Subroutine - Calibrate_Qtis ]-----
Calibrate_Qtis:
HIGH qtiPwrLeft           ' Turn left QTI on
HIGH qtiSigLeft           ' Discharge capacitor
PAUSE 1

RCTIME qtiSigLeft, 1, temp ' Measure charge time

LOW qtiPwrLeft            ' Turn left QTI off
multi = temp              ' Free temp for another RCTIME

HIGH qtiPwrRight          ' Turn right QTI on
HIGH qtiSigRight          ' Discharge capacitor
PAUSE 1
RCTIME qtiSigRight, 1, temp ' Measure charge time

multi = (multi + temp) / 2 ' Calculate average

multi = multi / 4         ' Take 1/4 average

IF multi > 220 THEN      ' Account for code overhead
  multi = multi - 220
ELSE
  multi = 0
ENDIF

WRITE QtiThresh, Word multi ' Threshold to EEPROM

RETURN
' -----[ Subroutine - Servos_And_Sensors ]-----
Servos_And_Sensors:
#IF DEBUG_MODE = 1 #THEN
  GOSUB Display_All       ' Call Display_All subroutine
#ENDIF

GOSUB Pulse_Servos       ' Call Pulse_Servos subroutine
' Call sensor subroutine(s).

sensors = 0              ' Clear previous sensor values

GOSUB Read_Object_Detectors ' Call Read_Object_Detectors
GOSUB Read_Line_Sensors   ' Look for lines

```

```

RETURN

' -----[ Subroutine - Pulse_Servos ]-----
Pulse_Servos:

' Pulse to left servo
LOOKUP maneuver, [ FS_CCW, FS_CW, FS_CW, FS_CCW,
                  NO_ROT, FS_CCW, LS_CCW, FS_CCW ], temp
PULSOUT ServoLeft, temp

' Pulse to right servo
LOOKUP maneuver, [ FS_CW, FS_CCW, FS_CW, FS_CCW,
                  FS_CW, NO_ROT, FS_CW, LS_CW ], temp
PULSOUT ServoRight, temp

' Pause between pulses (remove when using IR object detectors + QTIs).
' PAUSE 20

RETURN

' -----[ Subroutine - Read_Object_Detectors ]-----
Read_Object_Detectors:

FREQOUT IrLedRS, 1, IrFreq           ' Right side IR LED headlight
irRS = ~IrSenseRS                   ' Save right side IR receiver

FREQOUT IrLedRF, 1, IrFreq           ' Repeat for right-front
irRF = ~IrSenseRF

FREQOUT IrLedLF, 1, IrFreq           ' Repeat for left-front
irLF = ~IrSenseLF

FREQOUT IrLedLS, 1, IrFreq           ' Repeat for left side
irLS = ~IrSenseLS

RETURN

' -----[ Subroutine - Read_Line_Sensors ]-----
Read_Line_Sensors:

HIGH qtiPwrLeft                      ' Turn on QTIs
HIGH qtiPwrRight
HIGH qtiSigLeft                       ' Push signal voltages to 5 V
HIGH qtiSigRight
PAUSE 1                               ' Wait 1 ms for capacitors

READ QtiThresh, Word temp             ' Get threshold time

```

```

INPUT qtiSigLeft           ' Start the decays
INPUT qtiSigRight

PULSOUT DummyPin, temp    ' Wait threshold time

qtiLF = ~qtiSigLeft       ' Snapshot of QTI signal states
qtiRF = ~qtiSigRight

LOW qtiPwrLeft            ' Turn off QTIS
LOW qtiPwrRight

RETURN

' -----[ Subroutine - Avoid_Tawara_Left ]-----
Avoid_Tawara_Left:

#IF DEBUG_MODE = 1 #THEN state = ATL #ENDIF

FOR counter = 1 TO 15      ' Back up
  maneuver = Backward
  GOSUB Servos_And_Sensors
NEXT
FOR counter = 1 TO 15      ' Turn right
  maneuver = RotateRight
  GOSUB Servos_And_Sensors
NEXT

RETURN

' -----[ Subroutine - Avoid_Tawara_Right ]-----
Avoid_Tawara_Right:

#IF DEBUG_MODE = 1 #THEN state = ATR #ENDIF

FOR counter = 1 TO 15      ' Back up
  maneuver = Backward
  GOSUB Servos_And_Sensors
NEXT
FOR counter = 1 TO 15      ' Turn left
  maneuver = RotateLeft
  GOSUB Servos_And_Sensors
NEXT

RETURN

' -----[ Subroutine - Go_Forward ]-----
Go_Forward:

```



```

#IF DEBUG_MODE = 1 #THEN state = GF #ENDIF

maneuver = Forward           ' 1 forward pulse
GOSUB Servos_And_Sensors

RETURN

' -----[ Subroutine - Track_Front_Left_Object ]-----
Track_Front_Left_Object:

#IF DEBUG_MODE = 1 #THEN state = TFLO #ENDIF

counter = 0
DO UNTIL (irLF = 1 AND irRF = 1) OR counter > 15
  maneuver = CurveLeft       ' Curve left 15
  GOSUB Servos_And_Sensors
  counter = counter + 1
LOOP
DO UNTIL (irLF = 1 AND irRF = 1) OR counter > 30
  maneuver = RotateLeft     ' Rotate left 30
  GOSUB Servos_And_Sensors
  counter = counter + 1
LOOP

RETURN

' -----[ Subroutine - Track_Front_Right_Object ]-----
Track_Front_Right_Object:

#IF DEBUG_MODE = 1 #THEN state = TFRO #ENDIF

counter = 0
DO UNTIL (irLF = 1 AND irRF = 1) OR counter > 15
  maneuver = CurveRight     ' Curve right 15
  GOSUB Servos_And_Sensors
  counter = counter + 1
LOOP
DO UNTIL (irLF = 1 AND irRF = 1) OR counter > 30
  maneuver = RotateRight    ' Rotate right 30
  GOSUB Servos_And_Sensors
  counter = counter + 1
LOOP

RETURN

' -----[ Subroutine - Track_Side_Left_Object ]-----
Track_Side_Left_Object:

```

```

#IF DEBUG_MODE = 1 #THEN state = TSLO #ENDIF

DO UNTIL irRF = 1 OR irLF = 1           ' Rotate left
  maneuver = RotateLeft
  GOSUB Servos_And_Sensors
LOOP

RETURN

' -----[ Subroutine - Track_Side_Right_Object ]-----
Track_Side_Right_Object:

#IF DEBUG_MODE = 1 #THEN state = TSRO #ENDIF

DO UNTIL irRF = 1 OR irLF = 1           ' Rotate right
  maneuver = RotateRight
  GOSUB Servos_And_Sensors
LOOP

RETURN

' -----[ Subroutine - Search_Pattern ]-----
Search_Pattern:

#IF DEBUG_MODE = 1 #THEN state = SP #ENDIF

FOR counter = 1 TO 35                   ' and watch all sensors
  maneuver = Forward                    ' Forward
  GOSUB Servos_And_Sensors
  IF sensors <> 0 THEN GOTO Next_State
NEXT

Look_About:

#IF DEBUG_MODE = 1 #THEN state = SP #ENDIF

FOR counter = 1 TO 12                   ' Look right
  maneuver = RotateRight
  GOSUB Servos_And_Sensors
  IF sensors <> 0 THEN GOTO Next_State
NEXT
FOR counter = 1 TO 24                   ' Look left
  maneuver = RotateLeft
  GOSUB Servos_And_Sensors
  IF sensors <> 0 THEN GOTO Next_State
NEXT
FOR counter = 1 TO 12                   ' Re-align to forward
  maneuver = RotateRight

```

```

GOSUB Servos_And_Sensors
IF sensors <> 0 THEN GOTO Next_State
NEXT

Next_State:                                ' Exit point of search pattern

RETURN

' -----[ Subroutine - Display_All ]-----
#IF DEBUG_MODE = 1 #THEN

Display_All:

    DEBUG BIN8 sensors,                    ' Display sensors byte as bits
        CRSRX, 10                          ' Cursor to column 10

    SELECT state                            ' Display state
    CASE ATL
        DEBUG "ATL"
    CASE ATR
        DEBUG "ATR"
    CASE GF
        DEBUG "GF"
    CASE TFLO
        DEBUG "TFLO"
    CASE TFRO
        DEBUG "TFRO"
    CASE TSLO
        DEBUG "TSLO"
    CASE TSRO
        DEBUG "TSRO"
    CASE SP
        DEBUG "SP"
    ENDSELECT

    DEBUG CRSRX, 20                          ' Cursor to column 20

    SELECT maneuver                          ' Display maneuver
    CASE Forward
        DEBUG "Fwd"
    CASE Backward
        DEBUG "Bkwd"
    CASE RotateLeft
        DEBUG "RotLft"
    CASE RotateRight
        DEBUG "RotRt"
    CASE CurveLeft
        DEBUG "CrvLft"
    CASE CurveRight
        DEBUG "CrvRt"

```

```

ENDSELECT

DEBUG CR           ' Carriage return for next line

PAUSE 200         ' Pause 0.2 seconds for reading.

RETURN

#ENDIF
    
```

Your Turn

The bulk of the commands that are added to the program when **DEBUG_MODE** is set to 1 are **DEBUG** commands with strings of characters. The strings of characters take up a considerable amounts of memory. You can compare how much program memory is consumed by the diagnostic code as follows:

- √ Set **DEBUG_MODE** = 0.
- √ Click the BASIC Stamp Editor's Run menu, and select Memory map.

The Memory Map you see should resemble Figure 5-3. Notice on the left that the blue program codes are taking up less than half the BASIC Stamp's EEPROM.

Figure 5-3 Memory Map - **DEBUG_MODE** = 0

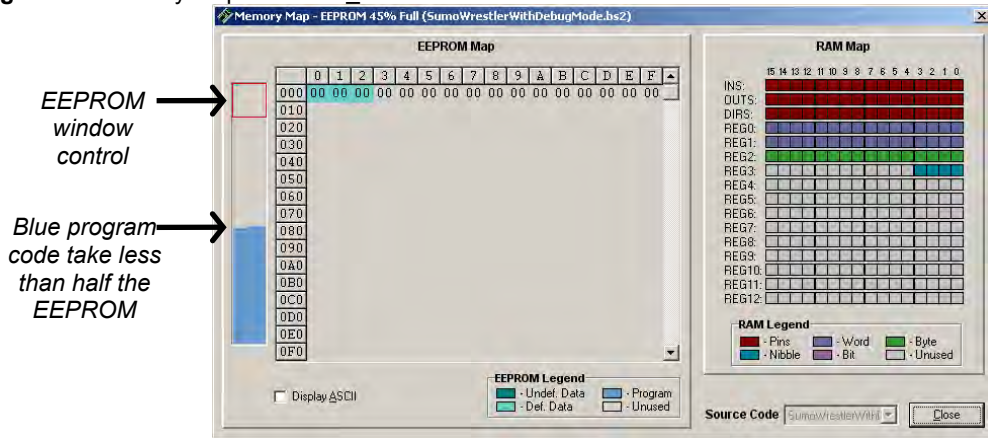

- √ Close the Memory Map.
- √ Set **DEBUG_MODE** = 1

- √ Click Run -> Memory map again and compare how much EEPROM is used by the code that was added for debugging.

ACTIVITY #4: DATALOGGING A COMPETITION ROUND

Displaying values in slow motion while the SumoBot is sitting still won't necessarily expose or solve problems the SumoBot has when it's up against another SumoBot in the competition ring. It's also not convenient to try to have a round while the SumoBot is tethered to the serial cable. Even if it was convenient, the serial communication of all those characters to the PC takes so much time that it would reduce the servos to twitching between each message.

5

This activity introduces a solution to the tether problem. The solution works like this: Save all the information the previous activity's example program displayed in EEPROM during the round. After the round is over, connect the SumoBot to the PC again, and have it display all the SumoBot's sensor readings, navigation states and maneuvers.

Logging and Reporting Routines

Another `#DEFINE` can be added to select the various datalogging features. In the next example program, the `DATALOG_MODE` symbol can be set equal to 0 (no logging), 1 (log round), or 2 (display logged round).

```
' -----[ Compiler Definitions ]-----
#DEFINE DEBUG_MODE = 1                ' 0 -> wrestle
                                       ' 1 -> display
#DEFINE DATALOG_MODE = 1              ' 0 -> No log
                                       ' 1 -> log round
                                       ' 2 -> display log
```

Since the same constants and variables that were used for debugging will be used for datalogging, the conditions of the compiler directives for these constants have to be updated. For example, the condition for the `#IF...#THEN` directive below used to be `DEBUG_MODE = 1`. Now, it's `DEBUG_MODE = 1 OR DATALOG_MODE > 0`. Why greater than zero? When `DATALOG_MODE` is set to 0, the datalogging features are not needed. However, when it's set to 1 or 2, the datalogging features should be compiled, and this includes the extra constants and variables used in the previous activity's debugging program.

```
#IF DEBUG_MODE = 1 OR DATALOG_MODE > 0 #THEN
  ' State constants.
  ATL          CON      0          ' Avoid_Tawara_Left
  ATR          CON      1          ' Avoid_Tawara_Right
  GF           CON      2          ' Go-Forward
  .
  .
#ENDIF
```

A constant named **MaxBytes** is declared to make it convenient to set the number of bytes that can be used for storing data logged during a round. In this example, **MaxBytes** is \$150. The \$ makes a number hexadecimal. A hexadecimal value is used because the Memory Map uses hexadecimal values. This makes it convenient to view the Memory Map and decide how much memory you have available for datalogging. \$10 (decimal-16) is subtracted from **MaxBytes** because the **DATA** directives that set aside EEPROM for storing records will begin at EEPROM address \$10.

```
#IF DATALOG_MODE > 0 #THEN
  ' Datalogging constants
  MaxBytes     CON      $150 - $10      ' Maximum number of bytes stored
#ENDIF
```

Recall from Chapter 2, Activity #1 that converting from hexadecimal to decimal involves multiplying the rightmost digit by $16^0 = 1$, the next digit by $16^1 = 16$, then next digit by $16^2 = 256$, and the next by $16^3 = 4096$, and so on. Add up all the products, and you'll have the decimal equivalent. For example, the decimal equivalent of \$150, is: $(1 \times 256) + (5 \times 16) + (0 \times 1) = \text{decimal } 336$.

It's more convenient to declare **MaxBytes** in terms of hexadecimal values because that's the way the EEPROM map displays all its addresses. Figure 5-4 shows the EEPROM map for the next example program compiled with **DATALOG_MODE = 2**. The highest EEPROM value not occupied by PBASIC program tokens is \$257. Since records will be stored as word values, each record will take up 2 bytes, and **MaxBytes** should be even. Therefore, **MaxBytes** could be declared as \$256 - \$10. This would use up all the available EEPROM.

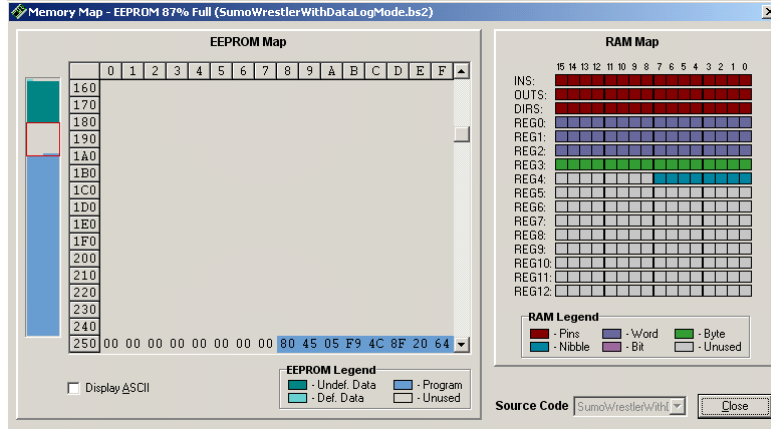

Figure 5-4
Memory Map

The highest EEPROM address not occupied by PBASIC program code is \$257.

5

An extra variable is necessary to keep track of which EEPROM byte gets the next record. This `logIndex` variable is used with the `WRITE` command for saving the records to EEPROM and with `READ` command to retrieve them.

```
#IF DATALOG_MODE > 0 #THEN
  logIndex  VAR      Word           ' Stores EEPROM index
#ENDIF
```

`DATA` directives should always be used to set aside EEPROM space that you will be reading from and writing to. The `DATA` directive has to be slightly different depending on whether the `DATALOG_MODE` is 1 or 2. If it's 1, new values will be recorded, and it helps to make sure there aren't any values from a previous round still being stored. Especially if you stop the round early, it will be easier to discern after which record you stopped the match, because the rest will be 0. That's the purpose of the first `LogData` directive. It sets all the EEPROM bytes from \$10 to `MaxBytes` (\$150) to 0.

```
#IF DATALOG_MODE = 1 #THEN
  LogData   DATA    @$10, 0 (MaxBytes) ' EEPROM data recording space
#ENDIF

#IF DATALOG_MODE = 2 #THEN
  LogData   DATA    @$10, (MaxBytes)   ' EEPROM playback space
#ENDIF
```

The `LogData DATA` directive that is declared when `DATALOG_MODE = 2` does not have a 0 before (`MaxBytes`). With this change, instead of writing zeros to all those EEPROM addresses, the program just reserves the space as undefined data. This is important

because we do not want to overwrite all the recorded records from the round the SumoBot just finished before they get displayed.

DATALOG_MODE = 2 is for playing back the recorded values from EEPROM. This playback will use all the features that **DEBUG_MODE = 1** used in the previous activity's example program. This **#IF** statement used to just have the **DEBUG_MODE = 1** condition. Now, it also has the **DATALOG_MODE = 2** condition. The **OR** operator makes it so that either or both of the conditions can be true for the **DEBUG** command to get compiled.

```
#IF DEBUG_MODE = 1 OR DATALOG_MODE = 2 #THEN
  DEBUG CLS,
    "Sensors   State     Maneuver", CR, ' Display table heading
    "-----  -"
#ENDIF
```

When the program is run as **DATALOG_MODE = 1**, word values are stored in EEPROM with the **WRITE** command. Figure 5-5 shows a map of each word. Each word value has the **sensors** variable copied to its **.HIGHBYTE**. Two nibbles are also copied to its **.LOWBYTE**. **NIB1** gets the value of the **state** variable, and **NIB0** gets the value of the **maneuver** variable.

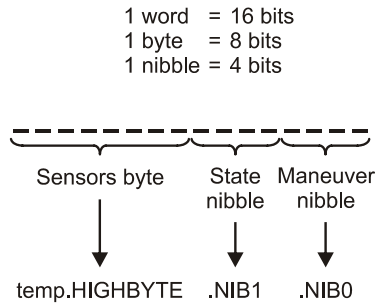

Figure 5-5
Datalogged Word Variable

Two nibbles and a byte are copied to different parts of a word variable before it is copied to an EEPROM address.

When **DEBUG_MODE** is 1, the **sensors**, **state**, and **maneuver** variables are all stored to EEPROM between each servo pulse. The best way to do this is by copying them to different parts of a word variable, and then storing that word variable in EEPROM with a **WRITE** command. As with the **DEBUG_MODE = 1** code, the best place for the **DATALOG_MODE = 1** code is also at the beginning of the **Servos_And_Sensors** subroutine.

```
' -----[ Subroutine - Servos_And_Sensors ]-----
Servos_And_Sensors:
  #IF DEBUG_MODE = 1 #THEN
    GOSUB Display_All           ' Call Display_All subroutine
  #ENDIF

  #IF DATALOG_MODE = 1 #THEN
    temp.HIGHBYTE = sensors     ' Copy values to parts of temp
    temp.NIB1 = state
    temp.NIB0 = maneuver
    WRITE LogData + LogIndex, Word temp ' Store record in EEPROM
    logIndex = logIndex + 2     ' Word values -> index + 2
    IF logIndex >= (LogData + MaxBytes) THEN END
  #ENDIF
  .
  .
  .
```

The last conditional compiler directive in the initialization section sends the program to a label named `Playback_Round` if `DATALOG_MODE = 2`.

```
#IF DATALOG_MODE = 2 #THEN
  GOTO Playback_Round         ' Alternate main routine
#ENDIF

GOSUB Look_About             ' Was Goto Look_About
```

The `Playback_Round` label comes after the `DO...LOOP` in the Main Routine. It's kind of like an alternate main routine when `DATALOG_MODE = 2`. It contains a `FOR...NEXT` loop that takes the `logIndex` variable from 0 to `MaxBytes` in steps of 2. Each time through the loop, the `READ LogData + logIndex, Word temp` command copies the word at the EEPROM address `LogData + logIndex` into the `temp` variable. The `.HIGHBYTE` of the `temp` variable is then copied to the `sensors` variable. `temp.NIB1` is copied to the `state` variable, and `temp.NIB0` is copied to the `maneuver` variable. Once those three variables contain the values from a given record, the `Display_All` subroutine is called, and a new line of values appears in the Debug Terminal before the `FOR...NEXT` loop does its next iteration.

```
' -----[ Main Routine ]-----
DO
  .
  .
  .
LOOP
```

```
#IF DATALOG_MODE = 2 #THEN

  Playback_Round:

    FOR logIndex = 0 TO MaxBytes STEP 2      ' Loop gets all records

      READ LogData + logIndex, Word temp    ' Get record
      sensors = temp.HIGHBYTE              '
      state = temp.NIB1
      maneuver = temp.NIB0
      GOSUB Display_All

    NEXT

  END

#ENDIF
```

The same **state** variable that was updated by the navigation subroutines for the previous example program also has to be updated when **DATALOG_MODE = 1**. This ensures that correct state values are written to EEPROM.

```
' -----[ Subroutine - Avoid_Tawara_Left ]-----
Avoid_Tawara_Left:

  #IF DEBUG_MODE = 1 OR DATALOG_MODE = 1 #THEN state = ATL #ENDIF
  .
  .
  .
' -----[ Subroutine - Avoid_Tawara_Right ]-----
Avoid_Tawara_Right:

  #IF DEBUG_MODE = 1 OR DATALOG_MODE = 1 #THEN state = ATR #ENDIF
  .
  .
  .
' -----[ Subroutine - Go_Forward ]-----
Go_Forward:

  #IF DEBUG_MODE = 1 OR DATALOG_MODE = 1 #THEN state = GF #ENDIF
  .
  .
  .
```

To display all the datalogged values when `DATALOG_MODE = 2`, the same `Display_All` subroutine from the previous activity's example program is used. So, its conditional compiler directive has to be adjusted as well.

```
' -----[ Subroutine - Display_All ]-----
#IF DEBUG_MODE = 1 OR DATALOG_MODE = 2 #THEN
.
.
.
```

Example Program: SumoWrestlerWithDataLogMode.bs2

This example program can be used to both record and play back the EEPROM values recorded by a match. You can use it to see what the SumoBot saw and understand what decisions it made during a round. It will be especially useful for both tuning the sensors and making adjustments to your competition code. Any time the SumoBot makes a move that causes it to lose a round, you can use this program to understand how it happened and correct the problem.

The program has the same debugging functionality as the previous activity's example program. It's best to start by leading the SumoBot around with your hand so that you can have a good guess which sensors detect your hand and which maneuvers it should make. When you use two SumoBots make sure that both are logging data. Reason being, the `WRITE` commands between pulses extend the low time long enough that it slows down the servos slightly. If both are logging data, the playing field is still even.



Did you skip ahead to get here? If you skipped any thing in Chapter 3 or 4, go back and do it now.

The programs that follow are dependent upon the sensor circuits built, tested and calibrated in the previous activities in Chapter 3 and 4.

- √ Enter and save SumoWrestlerWithDataLogMode.bs2
- √ To log a match, start by setting `DEBUG_MODE = 0` and `DATALOG_MODE = 1`.
- √ Download the program to the SumoBot and disconnect the serial cable.
- √ Place it on the competition ring, and press and release the Reset button.
- √ Place your hand in front of various object detectors as you make mental notes of how it responds.

- √ The SumoBot will log data as it competes for just under 10 seconds, then it stops.
- √ After the SumoBot stops, connect it to the serial cable.
- √ Change `DATALOG_MODE = 1` to `DATALOG_MODE = 2`.
- √ Run the program and leave the SumoBot connected to the serial cable.
- √ Press/release the Reset button. After the speaker beeps 5 times, it will display the logged data to the Debug Terminal in the same format as the previous activity.
- √ Compare what the Debug Terminal shows to the different sensor conditions the SumoBot must have seen as you lead it around with your hand.
- √ Start practicing this with both your SumoBots set to log data (`DATALOG_MODE = 1`). It will be important to watch them closely, and then examine their data to determine the factors that contribute to victories or losses. You can then adjust the sensors and/or the program to improve its performance.

As you expand and modify your program, the accuracy of `DATALOG_MODE` recording and playback may have to be checked. One way to do this is by setting the `DEBUG_MODE` and `DATALOG_MODE` values to 1. You can then view the data before it is recorded. Then, set `DEBUG_MODE` to 0 and `DATALOG_MODE` to 2 for playback, and compare the two. As with the previous activity, it will help to have the 3-position power switch set to 1 and a controlled set of objects and tawara lines.

```
' -----[ Title ]-----
' Applied Robotics with the SumoBot - SumoWrestlerWithDataLogMode.bs2
' SumoWrestler.bs2 modified so that each state is contained by a
' subroutine.

' {$STAMP BS2}                ' Target = BASIC Stamp 2
' {$PBASIC 2.5}              ' Language = PBASIC 2.5

' -----[ Compiler Definitions ]-----

#define DEBUG_MODE = 0        ' 0 -> wrestle
                             ' 1 -> display
#define DATALOG_MODE = 1    ' 0 -> No log
                             ' 1 -> log round
                             ' 2 -> display log

' -----[ I/O Definitions ]-----

ServoLeft    PIN    13        ' Left servo connected to P13
ServoRight   PIN    12        ' Right servo connected to P12
```

```

qtiPwrLeft    PIN    10    ' Left QTI on/off pin P10
qtiSigLeft    PIN    9      ' Left QTI signal pin P9

qtiPwrRight   PIN    7      ' Right QTI on/off pin P7
qtiSigRight   PIN    8      ' Right QTI signal pin P8

DummyPin      PIN    6      ' I/O pin for pulse-decay P6

LedSpeaker    PIN    5      ' LED & speaker connected to P5

IrLedLS       PIN    2      ' Left IR LED connected to P2
IrSenseLS     PIN    1      ' Left IR detector to P1

IrLedLF       PIN    4      ' Left IR LED connected to P4
IrSenseLF     PIN    11     ' Left IR detector to P11

IrLedRF       PIN    15     ' Right IR LED connected to P15
IrSenseRF     PIN    14     ' Right IR detector to P14

IrLedRS       PIN    3      ' Right IR LED connected to P3
IrSenseRS     PIN    0      ' Right IR detector to P0

' ----- [ Constants ] -----

' SumoBot maneuvers

Forward       CON    0      ' Forward
Backward      CON    1      ' Backward
RotateLeft    CON    2      ' RotateLeft
RotateRight   CON    3      ' RotateRight
PivotLeft     CON    4      ' Pivot to the left
PivotRight    CON    5      ' Pivot to the right
CurveLeft     CON    6      ' Curve to the left
CurveRight    CON    7      ' Curve to the right

' Servo pulse width rotations

FS_CCW        CON    850    ' Full speed counterclockwise
FS_CW         CON    650    ' Full speed clockwise
NO_ROT        CON    750    ' No rotation
LS_CCW        CON    770    ' Low speed counterclockwise
LS_CW         CON    730    ' Low speed clockwise

' IR object detectors

IrFreq        CON    38500   ' IR LED frequency

#IF DEBUG_MODE = 1 OR DATALOG_MODE > 0 #THEN
' State constants.
ATL           CON    0      ' Avoid_Tawara_Left
ATR           CON    1      ' Avoid_Tawara_Right

```

```

GF          CON      2          ' Go-Forward
TFLO       CON      3          ' Track_Front_Left_Object
TFRO       CON      4          ' Track_Front_Right_Object
TSLO       CON      5          ' Track_Side_Left_Object
TSRO       CON      6          ' Track_Side_Right_Object
SP         CON      7          ' Search_Pattern
#ENDIF

#IF DATALOG_MODE > 0 #THEN

  ' Datalogging constants

  MaxBytes  CON      $150 - $10      ' Maximum number of bytes stored
#ENDIF

' -----[ Variables ]-----

temp       VAR      Word          ' Temporary variable
multi     VAR      Word          ' Multipurpose variable
counter    VAR      Byte          ' Loop counting variable.

maneuver   VAR      Nib           ' SumoBot travel maneuver

sensors    VAR      Byte          ' Sensor flags byte

qtiLF     VAR      sensors.BIT5    ' Stores snapshot of QtiSigLeft
qtiRF     VAR      sensors.BIT4    ' Stores snapshot of QtiSigRight

irLS      VAR      sensors.BIT3    ' State of Left Side IR
irLF      VAR      sensors.BIT2    ' State of Left Front IR
irRF      VAR      sensors.BIT1    ' State of Right Front IR
irRS      VAR      sensors.BIT0    ' State of Right Side IR

state     VAR      Nib            ' State machine value

#IF DATALOG_MODE > 0 #THEN
  logIndex VAR      Word          ' Stores EEPROM index
#ENDIF

' -----[ EEPROM Data ]-----

RunStatus  DATA    0              ' Run status EEPROM byte
QtiThresh  DATA    Word 0         ' Word for QTI threshold time

#IF DATALOG_MODE = 1 #THEN
  LogData   DATA    @$10, 0 (MaxBytes) ' EEPROM data recording space
#ENDIF

#IF DATALOG_MODE = 2 #THEN
  LogData   DATA    @$10, (MaxBytes)  ' EEPROM playback space

```

```

#ENDIF

' -----[ Initialization ]-----

GOSUB Reset                ' Wait for Reset press/release
GOSUB Start_Delay          ' 5 Second delay
GOSUB Calibrate_Qtis       ' Determine b/w threshold

#IF DEBUG_MODE = 1 OR DATALOG_MODE = 2 #THEN
  DEBUG CLS,
    "Sensors   State   Maneuver", CR, ' Display table heading
    "-----", CR
#ENDIF

#IF DATALOG_MODE = 2 #THEN
  GOTO Playback_Round      ' Alternate main routine
#ENDIF

GOSUB Look_About          ' Was Goto Look_About

' -----[ Main Routine ]-----

DO

  IF qtiLF = 1 THEN        ' Left qti sees line?
    GOSUB Avoid_Tawara_Left ' State = avoid left tawara
  ELSEIF qtiRF = 1 THEN    ' Right qti sees line?
    GOSUB Avoid_Tawara_Right ' State = avoid right tawara
  ELSEIF irLF = 1 AND irRF = 1 THEN ' Both? Lunge forward
    GOSUB Go_Forward        ' State = Go forward
  ELSEIF irLF = 1 THEN     ' Just left?
    GOSUB Track_Front_Left_Object ' State = Track front left obj.
  ELSEIF irRF = 1 THEN     ' Just right?
    GOSUB Track_Front_Right_Object ' State = Track front right obj.
  ELSEIF irLS = 1 THEN     ' Left side?
    GOSUB Track_Side_Left_Object  ' State = track side left obj.
  ELSEIF irRS = 1 THEN     ' Right side?
    GOSUB Track_Side_Right_Object ' State = track side right obj.
  ELSE                     ' Nothing sensed?
    GOSUB Search_Pattern        ' State = Search pattern
  ENDIF

LOOP

#IF DATALOG_MODE = 2 #THEN

  Playback_Round:

    FOR logIndex = 0 TO MaxBytes STEP 2 ' Loop gets all records

      READ LogData + logIndex, Word temp ' Get record

```

```

    sensors = temp.HIGHBYTE
    state = temp.NIB1
    maneuver = temp.NIB0
    GOSUB Display_All

NEXT

END

#ENDIF

' -----[ Subroutine - Reset ]-----
Reset:

READ RunStatus, temp           ' Byte @RunStatus -> temp
temp = temp + 1                ' Increment temp
WRITE RunStatus, temp          ' Store new value for next time

IF (temp.BIT0 = 1) THEN        ' Examine temp.BIT0
    DEBUG CLS, "Press/release Reset", CR, ' 1 -> end, 0 -> keep going
    "button..."
END
ELSE
    DEBUG CR, "Program running..."
ENDIF

RETURN

' -----[ Subroutine - Start_Delay ]-----
Start_Delay:

FOR counter = 1 TO 5           ' 5 beeps, 1/second
    PAUSE 900
    FREQOUT LedSpeaker, 100, 3000
NEXT

RETURN

' -----[ Subroutine - Calibrate_Qtis ]-----
Calibrate_Qtis:

HIGH qtiPwrLeft                ' Turn left QTI on
HIGH qtiSigLeft                ' Discharge capacitor
PAUSE 1

RCTIME qtiSigLeft, 1, temp     ' Measure charge time

LOW qtiPwrLeft                 ' Turn left QTI off

```



```

multi = temp                                ' Free temp for another RCTIME

HIGH qtiPwrRight                            ' Turn right QTI on
HIGH qtiSigRight                            ' Discharge capacitor
PAUSE 1
RCTIME qtiSigRight, 1, temp                 ' Measure charge time

multi = (multi + temp) / 2                  ' Calculate average

multi = multi / 4                           ' Take 1/4 average

IF multi > 220 THEN                          ' Account for code overhead
  multi = multi - 220
ELSE
  multi = 0
ENDIF

WRITE QtiThresh, Word multi                 ' Threshold to EEPROM

RETURN

' -----[ Subroutine - Servos_And_Sensors ]-----
Servos_And_Sensors:

#IF DEBUG_MODE = 1 #THEN
  GOSUB Display_All                          ' Call Display_All subroutine
#ENDIF

#IF DATALOG_MODE = 1 #THEN
  temp.HIGHBYTE = sensors                   ' Copy values to parts of temp
  temp.NIB1 = state
  temp.NIB0 = maneuver
  WRITE LogData + LogIndex, Word temp       ' Store record in EEPROM
  logIndex = logIndex + 2                  ' Word values -> index + 2
  IF logIndex >= (LogData + MaxBytes) THEN END
#ENDIF

GOSUB Pulse_Servos                          ' Call Pulse_Servos subroutine

' Call sensor subroutine(s).

sensors = 0                                 ' Clear previous sensor values

GOSUB Read_Object_Detectors                 ' Call Read_Object_Detectors
GOSUB Read_Line_Sensors                    ' Look for lines

RETURN

' -----[ Subroutine - Pulse_Servos ]-----

```

```

Pulse_Servos:

' Pulse to left servo
LOOKUP maneuver, [ FS_CCW, FS_CW, FS_CW, FS_CCW,
                  NO_ROT, FS_CCW, LS_CCW, FS_CCW ], temp
PULSOUT ServoLeft, temp

' Pulse to right servo
LOOKUP maneuver, [ FS_CW, FS_CCW, FS_CW, FS_CCW,
                  FS_CW, NO_ROT, FS_CW, LS_CW ], temp
PULSOUT ServoRight, temp

' Pause between pulses (remove when using IR object detectors + QTIs).
' PAUSE 20

RETURN

' -----[ Subroutine - Read_Object_Detectors ]-----
Read_Object_Detectors:

FREQOUT IrLedRS, 1, IrFreq          ' Right side IR LED headlight
irRS = ~IrSenseRS                  ' Save right side IR receiver

FREQOUT IrLedRF, 1, IrFreq          ' Repeat for right-front
irRF = ~IrSenseRF

FREQOUT IrLedLF, 1, IrFreq          ' Repeat for left-front
irLF = ~IrSenseLF

FREQOUT IrLedLS, 1, IrFreq          ' Repeat for left side
irLS = ~IrSenseLS

RETURN

' -----[ Subroutine - Read_Line_Sensors ]-----
Read_Line_Sensors:

HIGH qtiPwrLeft                    ' Turn on QTIs
HIGH qtiPwrRight
HIGH qtiSigLeft                    ' Push signal voltages to 5 V
HIGH qtiSigRight
PAUSE 1                             ' Wait 1 ms for capacitors

READ QtiThresh, Word temp          ' Get threshold time

INPUT qtiSigLeft                   ' Start the decays
INPUT qtiSigRight

PULSOUT DummyPin, temp             ' Wait threshold time

```

```

qtiLF = ~qtiSigLeft           ' Snapshot of QTI signal states
qtiRF = ~qtiSigRight

LOW qtiPwrLeft                 ' Turn off QTIS
LOW qtiPwrRight

RETURN

' -----[ Subroutine - Avoid_Tawara_Left ]-----
Avoid_Tawara_Left:

#IF DEBUG_MODE = 1 OR DATALOG_MODE = 1 #THEN state = ATL #ENDIF

FOR counter = 1 TO 15           ' Back up
  maneuver = Backward
  GOSUB Servos_And_Sensors
NEXT
FOR counter = 1 TO 15           ' Turn right
  maneuver = RotateRight
  GOSUB Servos_And_Sensors
NEXT

RETURN

' -----[ Subroutine - Avoid_Tawara_Right ]-----
Avoid_Tawara_Right:

#IF DEBUG_MODE = 1 OR DATALOG_MODE = 1 #THEN state = ATR #ENDIF

FOR counter = 1 TO 15           ' Back up
  maneuver = Backward
  GOSUB Servos_And_Sensors
NEXT
FOR counter = 1 TO 15           ' Turn left
  maneuver = RotateLeft
  GOSUB Servos_And_Sensors
NEXT

RETURN

' -----[ Subroutine - Go_Forward ]-----
Go_Forward:

#IF DEBUG_MODE = 1 OR DATALOG_MODE = 1 #THEN state = GF #ENDIF

maneuver = Forward              ' 1 forward pulse
GOSUB Servos_And_Sensors

```

```

RETURN
' -----[ Subroutine - Track_Front_Left_Object ]-----
Track_Front_Left_Object:

#IF DEBUG_MODE = 1 OR DATALOG_MODE = 1 #THEN state = TFLO #ENDIF

counter = 0
DO UNTIL (irLF = 1 AND irRF = 1) OR counter > 15
  maneuver = CurveLeft          ' Curve left 15
  GOSUB Servos_And_Sensors
  counter = counter + 1
LOOP
DO UNTIL (irLF = 1 AND irRF = 1) OR counter > 30
  maneuver = RotateLeft        ' Rotate left 30
  GOSUB Servos_And_Sensors
  counter = counter + 1
LOOP

RETURN
' -----[ Subroutine - Track_Front_Right_Object ]-----
Track_Front_Right_Object:

#IF DEBUG_MODE = 1 OR DATALOG_MODE = 1 #THEN state = TFRO #ENDIF

counter = 0
DO UNTIL (irLF = 1 AND irRF = 1) OR counter > 15
  maneuver = CurveRight        ' Curve right 15
  GOSUB Servos_And_Sensors
  counter = counter + 1
LOOP
DO UNTIL (irLF = 1 AND irRF = 1) OR counter > 30
  maneuver = RotateRight      ' Rotate right 30
  GOSUB Servos_And_Sensors
  counter = counter + 1
LOOP

RETURN
' -----[ Subroutine - Track_Side_Left_Object ]-----
Track_Side_Left_Object:

#IF DEBUG_MODE = 1 OR DATALOG_MODE = 1 #THEN state = TSLO #ENDIF

DO UNTIL irRF = 1 OR irLF = 1          ' Rotate left
  maneuver = RotateLeft

```



```

RETURN
' -----[ Subroutine - Display_All ]-----
#IF DEBUG_MODE = 1 OR DATALOG_MODE = 2 #THEN

Display_All:

    DEBUG BIN8 sensors,           ' Display sensors byte as bits
        CRSRX, 10                 ' Cursor to column 10

    SELECT state                   ' Display state
    CASE ATL
        DEBUG "ATL"
    CASE ATR
        DEBUG "ATR"
    CASE GF
        DEBUG "GF"
    CASE TFLO
        DEBUG "TFLO"
    CASE TFRO
        DEBUG "TFRO"
    CASE TSLO
        DEBUG "TSLO"
    CASE TSRO
        DEBUG "TSRO"
    CASE SP
        DEBUG "SP"
    ENDSELECT

    DEBUG CRSRX, 20                ' Cursor to column 20

    SELECT maneuver                ' Display maneuver
    CASE Forward
        DEBUG "Fwd"
    CASE Backward
        DEBUG "Bkwd"
    CASE RotateLeft
        DEBUG "RotLft"
    CASE RotateRight
        DEBUG "RotRt"
    CASE CurveLeft
        DEBUG "CrvLft"
    CASE CurveRight
        DEBUG "CrvRt"
    ENDSELECT

    DEBUG CR                       ' Carriage return for next line

#IF DEBUG_MODE = 1 #THEN

```

```

    PAUSE 200           ' Pause 0.2 seconds for reading
  #ELSE
    PAUSE 50
  #ENDIF

RETURN

#ENDIF

```

Your Turn - Customizing Your SumoBot

The possibilities are endless for increasing your SumoBot's abilities. In personal robotics club competitions, SumoBots have been sighted with extensive modifications. One winning competitor used only the SumoBot printed circuit board and made a custom chassis, plow, and motors and sensors. When adding or substituting sensors, it's a good idea to use the same procedure this book used for sensors:

- (1) Write a small functional program to test the sensors.
- (2) Modify the program so that the sensor code is in a subroutine that controls a bit in the sensors variable. Your subroutine may also need to decide what value constitutes a 1 or 0 based on a measurement being above or below a threshold. The subroutine should also make use of the temp and counter variables whenever possible.
- (3) Integrate the Subroutine into your competition code. This may involve modifying the conditions for various navigation states, or even adding new navigation states.
- (4) Test the SumoBot's performance against another SumoBot in the competition ring.
- (5) Modify SumoWrestlerWithDataLogMode.bs2 so that it logs and displays any new navigation states, and use the program for trouble-shooting and refining the SumoBot's performance.

There are lots of sensors that may be useful to your customized SumoBot robot. The Ping))) Ultrasonic (distance) Sensor (#28015) and the Memsic 2125 Dual Axis Accelerometer (#28017) are two examples of the many sensors available at www.parallax.com. Each sensor page has documentation and example programs. Another example of a sensor idea is a custom contact sensor that can tell your SumoBot's BASIC Stamp whether its competitor's plow is above or below its plow. You can then experiment with writing code for navigation states that take evasive maneuvers.

Displaying the `sensors` variable can help for quick trouble-shooting between rounds. The LCD Terminal AppMod (#29121) is designed to be attached directly to the SumoBot board's AppMod Header for this purpose, but you will have to move some of your other sensors around to accommodate it. Another option is the Parallax Serial LCD (#27976), which only takes one I/O pin, and lots less code to control, and it can be used in place of the status LED and pushbutton.

Local robotics club competitions can be interesting, both to watch and to compete in. The SumoBots in these competitions will come in many different shapes, sizes, and strengths. It's best to consider your first time in a competition a reconnaissance experience. You will likely discover that some of these competitors have advantages that your practice SumoBot competitor never had. Watch each victory and loss carefully, not just with your SumoBot, but all the others too. It's crucial information so that you can customize your SumoBot for victory in future competitions.

SUMMARY

This chapter introduced three techniques to help find the cause(s) of SumoBot problem behaviors: (1) LED signals, (2) debugging routines, and (3) datalogging a sumo round. Conditional compiler directives were applied to all these techniques, so that you can change one or two values at the beginning of the program to either include or exclude your conditional LED/debugging/datalogging code from the program.

Questions

1. What are the five steps in the Scientific Method?
2. How can one line of code signal the occurrence of an event with an LED?
3. What are the advantages of turning and leaving the LED on when an event occurs?
4. What is branching?
5. What is conditional compiling?
6. What are some examples of things you can use `#DEFINE` to do?
7. What's the difference between `SELECT...CASE` and `#SELECT...#CASE`?
8. Is it possible to put constant declarations and `DATA` directives in conditional compiler directives, or just PBASIC commands?
9. Which two bits of the `sensors` variable are available if you want to add sensors?
10. What key features are missing that might prevent you from finding a bug while the SumoBot is connected to the serial cable displaying information on the Debug Terminal?
11. What are some examples of changes that had to be made to the conditional compiler directives in `SumoWrestlerWithPlayback.bs2`?
12. What's the purpose of the `Playback_Round` routine, and under what circumstances does that code get executed?
13. What role does the `temp` variable play in logging data?
14. How does the `temp` variable store more than one value in the program `SumoWrestlerWithDatalogMode.bs2`?

Exercises

1. Add LED events to the `Track_Front_Left_Object` subroutine that signal the start and end of each of its maneuvers.
2. Write conditional compiler directives to add IR interference testing to `SumoWrestlerWithDebugMode.bs2`.
3. Calculate how many records you can store with addresses \$10 to \$24F.

4. Modify SumoWrestlerWithDebugMode.bs2 so that it displays numbers next to each record.

Projects

1. Determine the average number of samples per second the SumoWrestlerWithDatalogMode.bs2 takes. If you have not already done so, modify the program so that it displays numbers next to each record. Use a stopwatch to identify certain events, then look for them by calculating the approximate record number that should hold the event.
2. Integrate the mode selection techniques introduced in Chapter 2, Activity #5 into SumoWrestlerWithDebugMode.bs2. When you are done, you should be able to use the pushbutton to select between the functions that used to be selected by `#DEFINE DEBUG_MODE`.



Appendix A: System Requirements and Parts Listing

System and Software Requirements

- PC running Windows® 2000/XP or higher operating system.
- Available serial port OR USB port with USB-to serial adapter (#800-00030)
- BASIC Stamp Editor for Windows v2.0 or higher
- Optional: BASIC Stamp source code for the experiments in this book, available for free download from www.parallax.com on the *Applied Robotics with the SumoBot* page (#27403).

The BASIC Stamp Editor is included on the Parallax CD in your kit. You may check for the latest versions at www.parallax.com under the Downloads menu.

Hardware Requirements

The *Applied Robotics with the SumoBot* text was written to accompany, and is included with, the SumoBot Robot Competition Kit (#27402). This kit's contents are listed in Table A-1. If you already have two individual SumoBot kits and you would like to try the experiments in this text, you would need to separately purchase the items in Table A-2. In either case, you will also need some common household items listed on page 257.

Table A-1: SumoBot Robot Competition Kit (#27402) Parts and quantities subject to change without notice		
Part #	Description	Quantity
27000	Parallax CD-ROM	1
27400	<i>SumoBot Manual</i>	1
27403	<i>Applied Robotics with the SumoBot text</i>	1
27404	SumoBot Competition Ring poster	1
150-02210	220 Ω resistors $\frac{1}{4}$ W 5%	6
150-04710	470 Ω resistors $\frac{1}{4}$ W 5%	8
150-01030	10 k Ω resistors $\frac{1}{4}$ W 5%	2
350-00003	LED-Infrared	10
350-00006	LED-Red	2
350-00014	IR Receiver	10
350-90000	LED Standoff	10
350-90001	LED Light Shield	10
400-00001	Pushbutton	2
555-27400	SumoBot printed circuit board	2
555-27401	QTI Line Sensor	4
700-00002	Machine screw, 4-40, 3/8" panhead	24
700-00003	4-40 nuts	24
700-00015	Nylon Washer #4	4
700-00016	Flat head screw, 4-40, 3/8"	4
700-00028	Screw, panhead, Phillips, 4-40, $\frac{1}{4}$ "	8
700-00064	Parallax screwdriver	1
710-00002	Screw, panhead, Phillips, 4-40, 1"	4
713-00001	Standoff, Alum, $\frac{1}{4}$ round, 5/8", 4-40	8
713-00002	Standoff, 1.25", 4/40, F to F	4
720-27403	SumoBot Chassis	2
720-27404	SumoBot Front Scoop	2
721-00001	Wheel, plastic, 2.58" diameter	4
721-00001	Rubber Band Tire for Wheel	8
753-00001	Battery holder, 4 cell AA, leads	2
800-00003	Serial cable	1
800-00016	Jumper wires, 3" (bag of 10)	3
805-00001	Servo extension cable	4
900-00001	Piezospoker	2
900-00008	Parallax Continuous Rotation Servo	4

Table A-2: For SumoBot Robots purchased separately Parts and quantities subject to change without notice		
Part#	Description	Quantity
27400	SumoBot Robot Kit	2
27403	<i>Applied Robotics with the SumoBot</i> text	1
27404	SumoBot Competition Ring poster	1
150-02210	220 Ω resistors $\frac{1}{4}$ W 5%	4
150-04710	470 Ω resistors $\frac{1}{4}$ W 5%	6
150-01030	10 k Ω resistors $\frac{1}{4}$ W 5%	2
350-00003	LED-Infrared	4
350-00014	IR Receiver	4
350-90000	LED Standoff	4
350-90001	LED Light Shield	4
400-00001	Pushbutton	2

Additional Items

You will also need several common tools and household items that are not included in your kit:

- Clear non-shiny cellophane tape
 - Needle-nose pliers
 - Small pulley, such as those used for screen doors
 - Fishing line
 - Disposable foam cup
 - Small weights (nails, nuts, washers, etc)
 - Gram scale, such as a diet or postal scale
 - Black felt-tip marker, such as a Sharpie[®] marker
-

Index

- # -
- #. *See* conditional compile directives
- \$ -
- \$. *See* hexadecimal, *See* compiler directives
- . -
- .BIT operator, 49
- .HIGHBYTE, 236
- .LOWBYTE, 236
- .NIB, 237
- @ -
- @Address operator, 46
- ~ -
- ~. *See* invert bits operator
- A -
- acceleration, 24
- Accelerometer, 251
- B -
- British Engineering
 - units, 23
- C -
- cgs units, 23
- coefficient of friction, 28, 31
- coefficients of friction, 29
- comment-out, 94
- compiler directives, 212, 213
- compile-time, 44
- conditional compile directives
 - #DEFINE, 212
 - #IF...#ENDIF, 213
 - #SELECT...#CASE, 213
- CRSRXY, 131
- D -
- DATA, 41
- DATA directive
 - @Address operator, 46
- datalogging, 233
- DEBUG, 131
 - CRSRXY, 131
- debugging, 216
- DEBUGIN, 51
- DO UNTIL...LOOP, 52
- dyne, 23
- E -
- EEPROM, 12, 41, 44
- EEPROM addresses, 42
- EEPROM vs. RAM, 47
- electrical continuity, 88
- F -
- Find/Replace, 128
- flag bits, 129
- flowcharts, 175
- force, iii, 7, 22, 23, 24, 25, 26, 27, 28, 31, 33
- free body diagram, 27
- frequency sweep, 92
- friction, 7

friction force, 31
friction forces, 26
frictional force diagram, 29

- G -

gram, 23
gravity, 24
Guarantee, 2

- H -

hardware requirements, 255
 additional household items, 257

hexadecimal, 234
hexadecimal conversion, 45, 234
hybrid state machine diagram, 175

- I -

IF...ELSEIF...ELSE...ENDIF, 143
input register, 61
invert bits operator, 117
IR interference, 85
IR LED, 78
IR object detection circuits, 79
IR Object Detection circuits, side-mounted, 119
IR object detection troubleshooting, 82
IR object detector range, 89
IR object detectors, 78
IR receiver frequency response, 91

- K -

kilogram, 23
kinetic friction, 26
kinetic objects, 27
kit contents. *See* Appendix A

- L -

LCD, 252

LED circuit, 59
LOOKUP, 61, 144, 148

- M -

mass, 23
mechanical advantage, 8
Memory Map, 45, 232
modified state machine diagram, 173
mu, 28

- N -

Newton, 23
Newton's second law of motion, 23
Newton's Third Law, 28
normal force, 26, 31

- P -

PBASIC commands

 DATA directives, 41
 DEBUG, 131
 DEBUGIN, 51
 DO UNTIL...LOOP, 52
 IF...ELSEIF...ELSE...ENDIF, 143
 LOOKUP, 61, 144, 148
 PULSOUT, 145
 RCTIME, 97
 READ, 42
 SELECT...CASE, 66
 WRITE, 42

piezospeaker circuit, 59
pliers, 89
plow adjustment, 8
plow adjustments, 9
pound, 23

programs

CompilerDirectives.bs2, 214
Forward100Pulses.bs2, 11
ForwardLowTimeTest.bs2, 18
FrontAndSideIrNavigation.bs2, 166
FrontIrNavigation.bs2, 159
IrInterferenceSniffer.bs2, 86
LookupExample.bs2, 149
PushbuttonLed.bs2, 172
PushbuttonMode.bs2, 67
QtiPulseDecayTrick.bs2, 114
QtiPulseTrickLeft.bs2, 111
QtiSelfCalibrate.bs2, 104
ResetAndStartMode.bs2, 71
ResetButtonCounter.bs2, 48
SearchPatternAndAvoidTawara.bs2, 178
SensorsWithTempVariables.bs2, 135
ServoControlExample.bs2, 146
ServoControlWithLookup.bs2, 152
SumoWrestler.bs2, 194
SumoWrestlerWithDataLogMode.bs2, 239
SumoWrestlerWithDebugMode.bs2, 222
SymbolNamesVsAddressContents.bs2, 44
TestAllSensors.bs2, 124
TestFrequencyResponse.bs2, 92
TestFrontIrObjectDetectors.bs2, 82
TestFrontQtiLineSensors.bs2, 100

TestLedSpeaker.bs2, 60
TestPushButton.bs2, 63
TestResetButton.bs2, 57
TestSideIrObjectDetectors.bs2, 120
TestSumoWrestler.bs2, 186
ThreeVariablesManyJobs.bs2, 53

pulley, 34
Pulse-Decay Trick, 108
Pulse-Decay Trick timing graph, 110
PULSOUT, 145
pushbutton circuit, 61
pushbutton program mode selection, 65

- Q -

QRD1114, 97
QTI Circuit, 108
QTI line sensors, 95
schematics, 96
testing, 95

QTIs self calibrating, 102

- R -

RAM, 47
RC-decay graph, 99
RCTIME, 97
READ, 42
Receive windowpane, 51
requery response, 92
Reset button program control, 55
reset state, 170
RPM calculation for servos, 22
run-time, 44

- S -

scale, 35

Scientific Method, 208
SELECT...CASE, 66
self calibrating QTI sensors, 102
sensor flags, 143
servo connections, 13
servo control, 145
servo rotational velocity graph, 146
servo RPM calculation, 21
servo slow-down, 16, 21
sigma, 27
slug, 23
software requirements, 255
state machine, 170
 reset state, 170
state machine diagram, hybrid, 175
state machine diagram, modified, 173
state machine.diagram, 171
static friction, 26
static objects, 27
SumoBot Competition Ring poster, 9
Symbol names, 41
System International (SI), 23

- T -

temporary variables, 51, 132
tilt detection, 102
Transmit windowpane, 50

- U -

Ultrasonic Sensor, 251
unit conversions, 24
Units of Force, Mass, and Acceleration,
23

- V -

variables, temporary, 51, 132
vectors, 26

- W -

weight, 22, 24
WRITE, 42

- M -

μ , 28